



第2代COB LED灯座 Holders for COB LEDs GEN 2

A.A.G. Stucchi 的所有产品都是“意大利制造”
All A.A.G. Stucchi products are “Made in Italy”

警告

- 此产品目前无法在德国销售
- 必须遵守LED生产商提供的规格。
- 必须遵守COB LED的极性。
- 建议在LED和散热片之间使用TIM（热接口材料）。为了实现恰当的热量管理和散热，必须遵守LED生产商的说明书上的要求。
- 强烈建议一次性使用8000/G2系列灯座。重复使用灯座可能会导致推入式端子和COB固定系统不能用。
- 根据EN/IEC 60838 标准的定义，8000/G2系列灯座必须被认为是“敞开式的”：COB LED正确安装进灯具才能保证防电击。
- 使用M3螺丝（最小长度7mm，最大扭矩0,5Nm）。
- 必须使用自锁螺丝或锁紧垫圈。

带额外金属板的“CM”版本

“CM”版本的灯座配多配了一块金属板，用于重载应用（如存在震动的情况、温度变化很大的室外应用等）。

金属板进一步保证了COB+灯座系统的稳定性和强度，使灯座可靠性最大化。

WARNINGS

- Products are not available for the german market
- Specifications of LED manufacturer must be observed.
- Polarity of COB LED must be observed.
- Use of a TIM (Thermal Interface Material) between the LED and the heat sink is recommended. For proper heat management and dissipation, instructions of LED manufacturer must be observed.
- Single use of 8000/G2 series holders is strongly recommended. Push-wire terminals and COB holding system failure could be faced trying to re-use an holder.
- Holders 8000/G2 series must be considered as “unenclosed” according to the definition stated in the EN/IEC 60838 standards: protection against electric shock is guaranteed when the COB LED is properly installed into the lighting fixture.
- Use M3 screws (min. length: 7mm - max. torque: 0,5Nm).
- Self-locking screws or locking washers must be always used.

VERSIONS “CM” WITH ADDITIONAL METAL PLATE

Holders “CM” versions are equipped with additional metal plates for use in heavy-duty applications (i.e. in presence of vibrations, in outdoor use with heavy temperature cycles). The metal plates assure a further stability and rigidity to the COB+holder system maximizing the holder reliability.

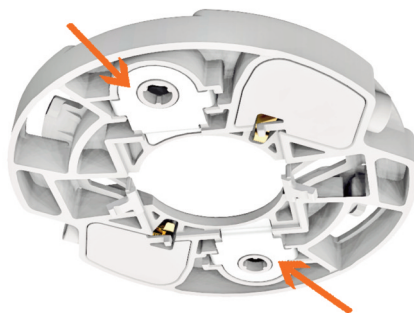

安装说明

COB支撑系统

8000/G2系列灯座拥有在处理和安装操作中可以支撑COB的系统。

为了恰当地将COB装入灯座，必须遵守下列说明：

INSTRUCTIONS

COB holding system

Holder 8000/G2 series are provided with a system to hold the COB during handling and mounting operation.

For a proper mounting of the COB in the holder the following instructions must be observed:



1) 将COB向塑料框一侧按。

1) Push the COB against one side of the plastic frame.

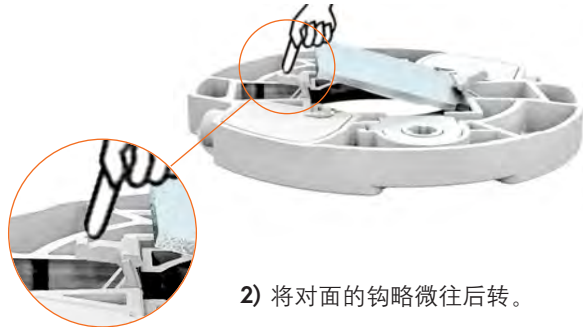

2) 将对面的钩略微往后转。

2) Slightly rotate the opposite hook backwards.



3) 在按住卡钩的同时将COB插入塑料框中。

3) Insert the COB into the plastic frame while holding back the hook.

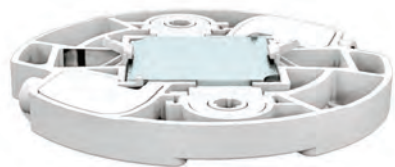

4) 松开卡钩。

4) Release the hook.

验证安装是否正确：

The proper mounting is verified if:



在处理 and 安装过程中对COB的控制很牢固。

The COB is held firmly during handling and mounting operations.



COB位于塑料框的正中心，在LES和灯座开口之间没有未对齐的COB位于塑料框的正中心，在LES和灯座开口之间没有未对齐的风险。

The COB is perfectly centered inside the plastic frame and there is no risk of misalignment between LES and holder opening.



灯座在散热片上的定位、对中和安装

将灯座定位，中心对准散热片上的孔然后固定，避免COB与散热片表面发生任何一点摩擦（这样就没有TIM发生损坏的风险）。

Positioning, centering and fixing of the holder on the heat sink

The holder can be positioned, centered on the heat sink holes and fixed avoiding any friction of the COB against the heat sink surface (with no risk of damaging the TIM).

COB固定钩让灯座在散热片上的定位更简单。

The COB holding hooks allow a easier positioning of the holder on the heat sink.

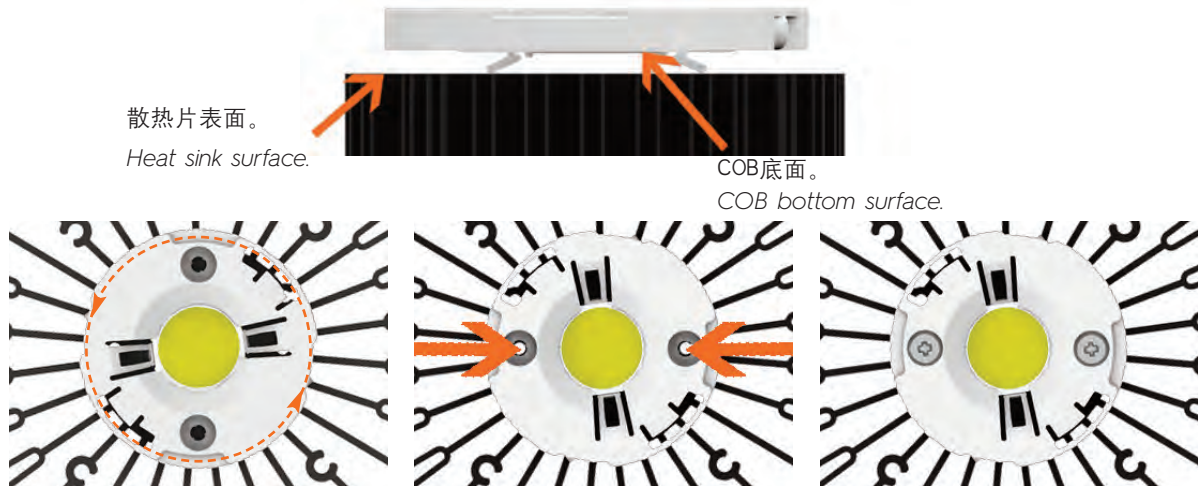

旋转灯座，让螺丝孔与散热片上的孔相匹配。

插入螺丝并拧紧（最大扭矩0.5 Nm）。

Rotate the holder so that the holes for screws match the holes on the heat sink.

Insert the screws and tighten (max. torque 0,5 Nm).

可以通过紧固螺丝进行灯座和散热片孔的预对中。

The pre-centering of the holder on the heat sink holes can be done by means of the fixing screws.



拧紧螺丝到其长度的一半（多亏底座的孔特别尖形状）。

Tighten the screws for half of their lenght (thanks to the holder holes special sharp).



旋转灯座，让螺丝进入散热片上的安装孔。

拧紧螺丝（最大扭矩0.5 Nm）。

Rotate the holder so that the screws get in the fixing holes on the heat sink.

Tighten the screws (max. torque 0,5 Nm).



将灯座固定到散热片上

螺丝紧固好后，两个塑料钩会向外弯，这样COB就可与散热片的表面相互重叠贴合。

Fixing the holder onto the heat sink

Once the screws are tightened the two plastic hooks bend outwards so that the COB can overlap the heatsink surface.

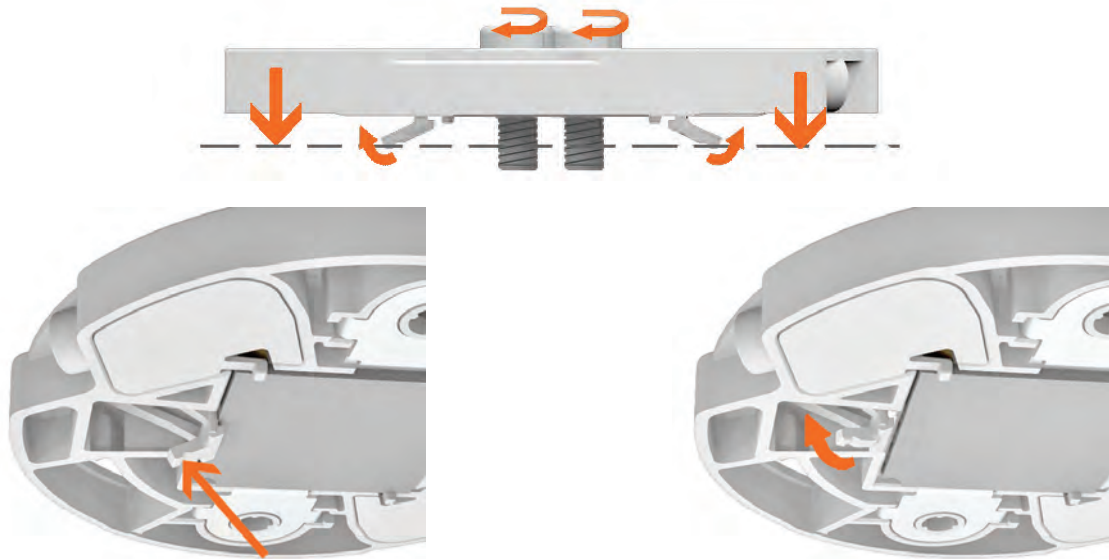

扭锁光学元件接口

8000/G2系列灯座拥有一个安装光学元件的扭锁接口。

Twist&Lock optics attachment interface

Holders series 8000/G2 are equipped with an interface for Twist&Lock optics fixing.

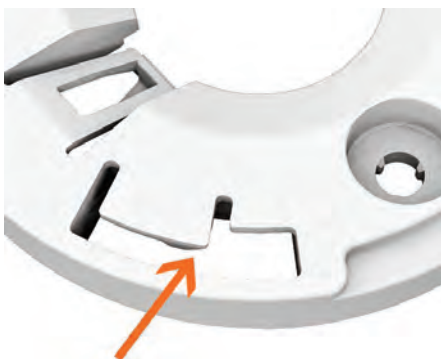

扭锁光学元件接口。

Interface for optics T&L attachment.



带L形针的光学元件。

Optic with "L" shaped pins.





1) 插入并旋转光学元件。

1) Insert and rotate the optic.

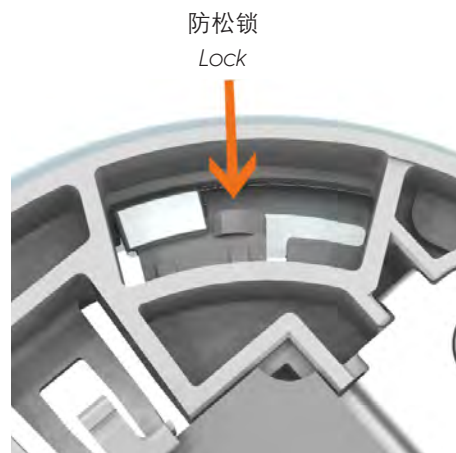

2) 光学元件锁紧后，防松锁就开始起作用了。

2) Once the optic is properly locked the anti-release lock comes into action.



注意：有固定间距35mm的灯座适用于：

- LEDIL的 ANGELA-B 和 ANGELINA-B 反光杯
- LEDIL的LENA和LENINA反光杯（幸亏使用了转换器）
- Almecco的**reflect+A™**反光杯

N.B.: Holders with fixing distance of 35mm are suitable for:

- ANGELA-B and ANGELINA-B reflectors by LEDIL.
- LENA and LENINA reflectors by LEDIL (thanks to the use of adaptors).
- **reflect+A™** reflectors by Almecco.

