

461/V-3

PORTALAMPADE PER LAMPADE FLUORESCENTI COMPATTE (TC-F) LAMPHOLDER FOR COMPACT FLUORESCENT LAMPS (TC-F)

Dati tecnici

Technical data









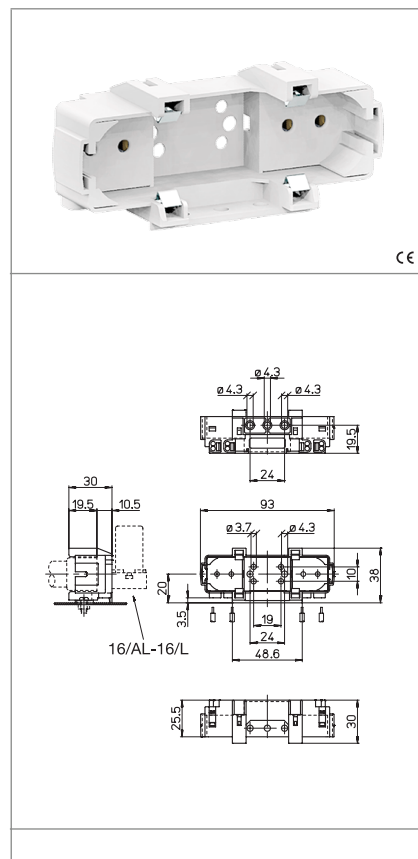



- Attacco lampada - Lamp Cap	2G10
- Corrente e tensione nominale - Rated current and voltage	2A-250V
- Temperatura massima di funzionamento (IEC) - Maximum operating temperature (IEC)	T140
- Grado di protezione - Protection index	IP20
- Categoria di sovratensione - Impulse withstand category	III

Caratteristiche

Characteristics

- Corpo in PBT bianco
- White PBT body
- Contatti in lega di rame
- Copper alloy contacts



 fissaggio con vite screw fixing	 altezza centro lampada (da sopra la lamiera) lamp centre height (from the top of the metal plate)	 serrafilo automatico a 2 fori push-wire terminals with 2 holes	 sezione conduttori rigidi rigid conductor section
 spelatura cavetti rigidi rigid wires stripping	 20	 120	 0,5-1
			

Marchi di qualità

Quality marks

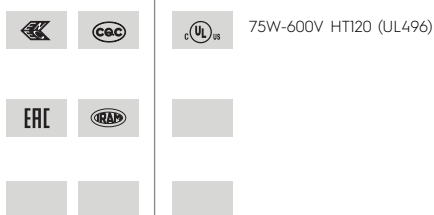

Direttive Europee

European directives

Conforme "RoHS"
"RoHS" compliant
Non soggetto alla "RAEE"
Not subject to "WEEE"

Pesi e confezioni

Weights and packaging

Art. Codice prodotti Product references	g Peso netto Net weight	n° pz per sacco per bag	n° pz per scatola per box	n° pz per cartone per carton
461/V-3	26,7		50	

Note

Notes