

289-SLS/SN-15-PBT

289-SLS/N-15-PBT

**PORTALAMPADE A COLONNA PER LAMPADE FLUORESCENTI T5 SEAMLESS
TOMBSTONE LAMPHOLDERS FOR T5 SEAMLESS LAMPS**

Dati tecnici

Technical data

- Attacco lampada - Lamp Cap	G5
- Corrente e tensione nominale - Rated current and voltage	2A-500V
- Temperatura massima di funzionamento (IEC) - Maximum operating temperature (IEC)	T140
- Grado di protezione - Protection index	IP20
- Categoria di sovratensione - Impulse withstand category	II

Caratteristiche

Characteristics

- Corpo in PBT bianco
- White PBT body
- Contatti in lega di rame
- Copper alloy contacts
- Con top test
- With top test

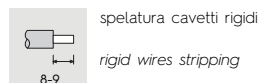
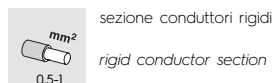
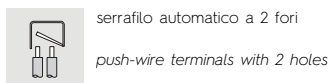
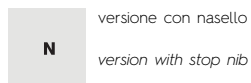
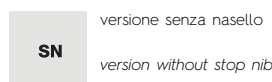
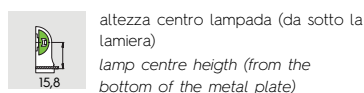
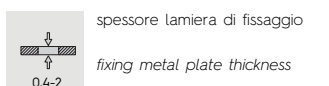
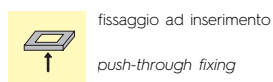
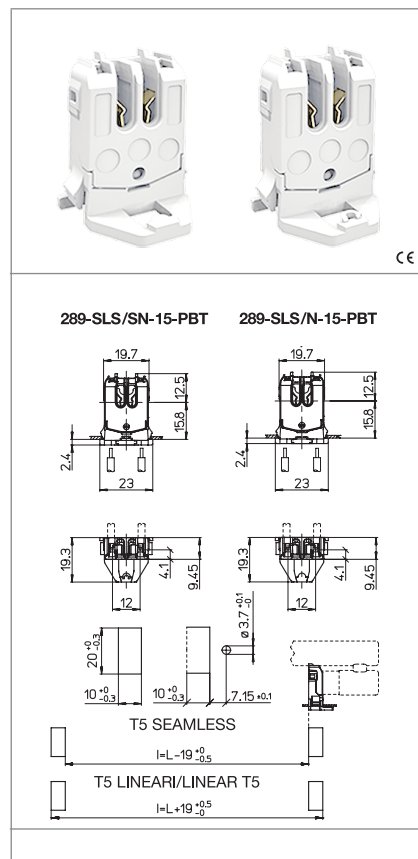

Marchi di qualità

Quality marks

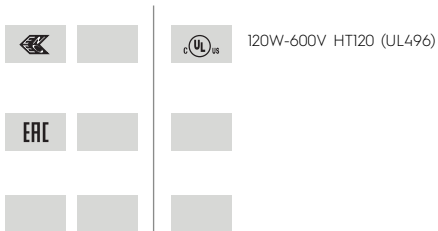

Direttive Europee

European directives

Conforme "RoHS"
"RoHS" compliant
Non soggetto alla "RAEE"
Not subject to "WEEE"

Pesi e confezioni

Weights and packaging

Art. Codice prodotti Product references	g Peso netto Net weight	n° pz per sacco per bag	n° pz per scatola per box	n° pz per cartone per carton
289-SLS/SN-15-PBT				
289-SLS/N-15-PBT				

Note

Notes