

7101/d1

PORTAMODULO PER MODULI LED - BOOK 8 ZHAGA HOLDER FOR LED MODULES - ZHAGA BOOK 8

Dati tecnici

Technical data

- Attacco - Base	PHJ85d-1
- Corrente e tensione nominale - Rated current and voltage	2A-250V
- Temperatura massima di funzionamento (IEC) - Maximum operating temperature (IEC)	T100
- Grado di protezione - Protection index	IP20
- Categoria di sovratensione - Impulse withstand category	II

Caratteristiche

Characteristics

- Corpo in PBT bianco
- White PBT body
- Contatti in lega di rame
- Copper alloy contacts

Viti M3 (min. 16mm - max. momento torcente 0,5Nm)
M3 screws (min. 16mm - max. torque 0,5Nm)

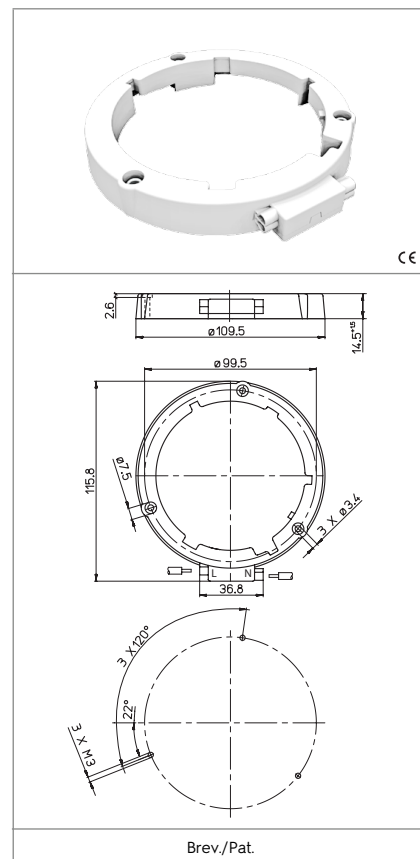

 fissaggio con vite screw fixing	 serrafilo automatico a 2 fori push-wire terminals with 2 holes	 sezione conduttori rigidi rigid conductor section	 diametro conduttore flessibile con fascetta diameter of the flexible conductor with ferrule
 spelatura cavetti rigidi e flessibili con fascetta rigid and flexible with ferrule wires stripping			

Marchi di qualità

Quality marks

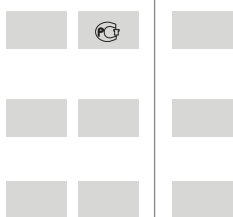

Direttive Europee

European directives

Conforme "RoHS"
"RoHS" compliant
Non soggetto alla "RAEE"
Not subject to "WEEE"

Pesi e confezioni

Weights and packaging

Art. Codice prodotti Product references	g Peso netto Net weight	n° pz per sacco per bag	n° pz per scatola per box	n° pz per cartone per carton
7101/d1	28,9		50	

Note

Notes