

**770/26**

**PORTALAMPADE PROTETTO PER LAMPADE FLUORESCENTI LINEARI T8**  
**PROTECTED LAMPHOLDER FOR T8 FLUORESCENT LINEAR LAMPS**

**Dati tecnici**

*Technical data*









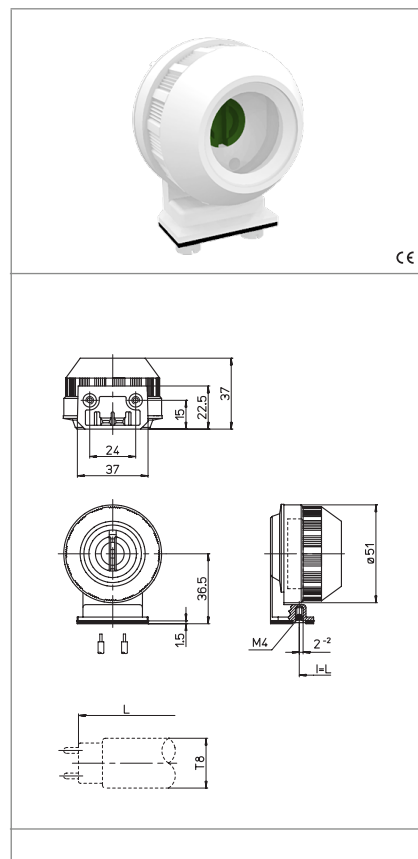



- Attacco lampada - Lamp Cap	G13
- Corrente e tensione nominale - Rated current and voltage	2A-250V
- Temperatura massima di funzionamento (IEC) - Maximum operating temperature (IEC)	T130 Tm110
- Grado di protezione - Protection index	IP66/67
- Categoria di sovratensione - Impulse withstand category	III

**Caratteristiche**

*Characteristics*

- Corpo in policarbonato bianco e PBT bianco  
- White polycarbonate and white PBT body
- Contatti in lega di rame  
- Copper alloy contacts
- Guarnizioni in neoprene/silicone  
- Neoprene/silicone gaskets



 fissaggio con vite <i>screw fixing</i>	 altezza centro lampada (da sopra la lamiera) <i>lamp centre height (from the top of the metal plate)</i>	 rotore in PBT verde con scatti di... <i>PBT green rotor with position of...</i>	 serrafilo automatico ad 1 foro <i>push-wire terminals with 1 hole</i>
 sezione conduttori rigidi <i>rigid conductor section</i>	 spelatura cavetti rigidi <i>rigid wires stripping</i>	 protetto IP66/67 <i>IP66/67 protected</i>	 798
			

**Marchi di qualità**

*Quality marks*

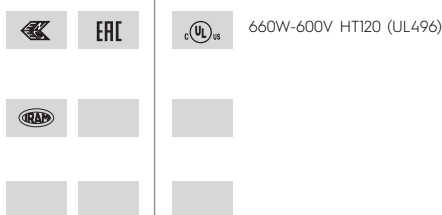

**Direttive Europee**

*European directives*

Conforme "RoHS"  
"RoHS" compliant  
Non soggetto alla "RAEE"  
Not subject to "WEEE"

**Pesi e confezioni**

*Weights and packaging*

Art. Codice prodotti Product references	g Peso netto Net weight	n° pz per sacco per bag	n° pz per scatola per box	n° pz per cartone per carton
770/26	44,9		50	

**Note**

*Notes*