

770/38

**PORTALAMPADE PROTETTO PER LAMPADE FLUORESCENTI LINEARI T8 + TUBO DI PROTEZIONE, T12
PROTECTED LAMPHOLDER FOR T8 + COVER TUBE, T12 FLUORESCENT LINEAR LAMPS**

Dati tecnici

Technical data







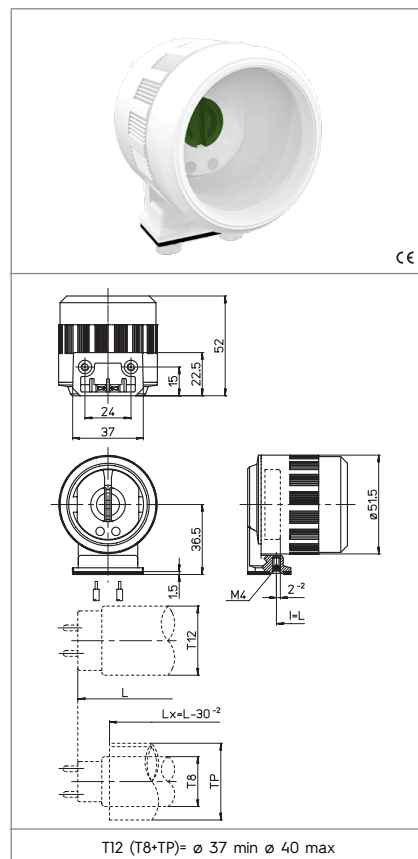

- Attacco lampada - Lamp Cap	G13
- Corrente e tensione nominale - Rated current and voltage	2A-250V
- Temperatura massima di funzionamento (IEC) - Maximum operating temperature (IEC)	T130 Tm110
- Grado di protezione - Protection index	IP66/67
- Categoria di sovratensione - Impulse withstand category	III

Caratteristiche

Characteristics

- Corpo in policarbonato bianco e PBT bianco
- White polycarbonate and white PBT body
- Contatti in lega di rame
- Copper alloy contacts
- Guarnizioni in neoprene/silicone
- Neoprene/silicone gaskets



 fissaggio con vite screw fixing	 altezza centro lampada (da sopra la lamiera) lamp centre height (from the top of the metal plate)	 rotore in PBT verde con scatti di... PBT green rotor with position of...	 serrafilo automatico ad 1 foro push-wire terminals with 1 hole
 sezione conduttori rigidi rigid conductor section	 spelatura cavetti rigidi rigid wires stripping	 protetto IP66/67 IP66/67 protected	 798

Marchi di qualità

Quality marks

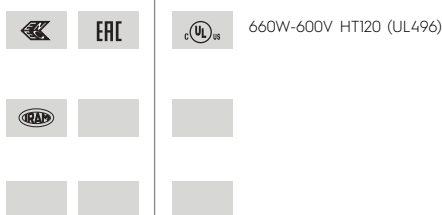

Direttive Europee

European directives

Conforme "RoHS"
"RoHS" compliant
Non soggetto alla "RAEE"
Not subject to "WEEE"

Pesi e confezioni

Weights and packaging

Art. Codice prodotti Product references	g Peso netto Net weight	n° pz per sacco per bag	n° pz per scatola per box	n° pz per cartone per carton
770/38	54,7		50	

Note

Notes