

## 2423/V-q3-4-T

### PORTALAMPADE MULTICHIAVE PER LAMPADE FLUORESCENTI COMPATTE (TC-DEL, TC-TEL) MULTI-KEYS LAMPHOLDERS FOR COMPACT FLUORESCENT LAMPS (TC-DEL, TC-TEL)

#### Dati tecnici

##### Technical data

- Attacco lampada - Lamp Cap	G24q-3 GX24q-3-4
- Corrente e tensione nominale - Rated current and voltage	2A-500V
- Temperatura massima di funzionamento (IEC) - Maximum operating temperature (IEC)	T140
- Grado di protezione - Protection index	IP20
- Categoria di sovratensione - Impulse withstand category	III





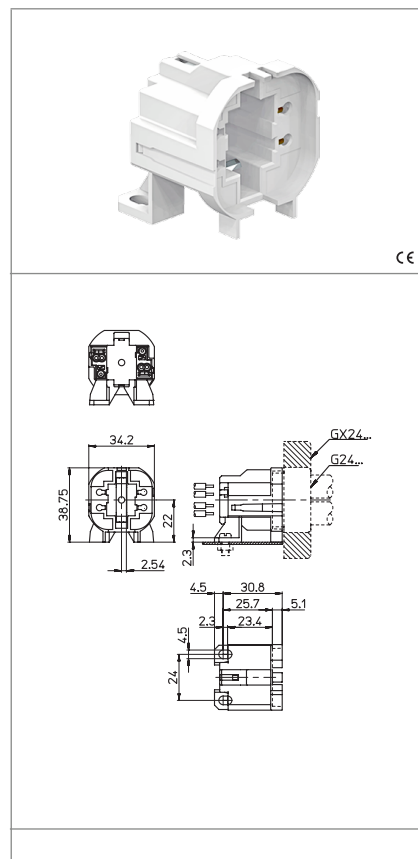

#### Caratteristiche

##### Characteristics

solo con reattori elettronici multipotenza  
with multipower electronic ballasts only

- Corpo in PBT bianco  
- White PBT body
- Contatti in lega di rame  
- Copper alloy contacts



 fissaggio con vite screw fixing	 altezza centro lampada (da sotto la lamiera) lamp centre height (from the bottom of the metal plate)	 serrafilo automatico a 2 fori push-wire terminals with 2 holes	 sezione conduttori rigidi rigid conductor section
 spelatura cavetti rigidi rigid wires stripping	 con fori di guida per i cavetti with wires guidance holes	 isolato in classe II class II insulated	

#### Marchi di qualità

##### Quality marks

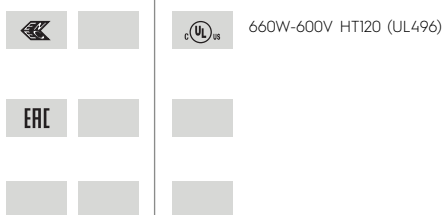

#### Direttive Europee

##### European directives

Conforme "RoHS"  
"RoHS" compliant  
Non soggetto alla "RAEE"  
Not subject to "WEEE"

#### Pesi e confezioni

##### Weights and packaging

Art. Codice prodotti Product references	g Peso netto Net weight	n° pz per sacco per bag	n° pz per scatola per box	n° pz per cartone per carton
2423/V-q3-4-T	14	500	100	

#### Note

##### Notes