

2675/A/43

MORSETTO PER APPARECCHI DI ILLUMINAZIONE
TERMINAL BLOCK FOR LIGHTING FIXTURES

Dati tecnici

Technical data







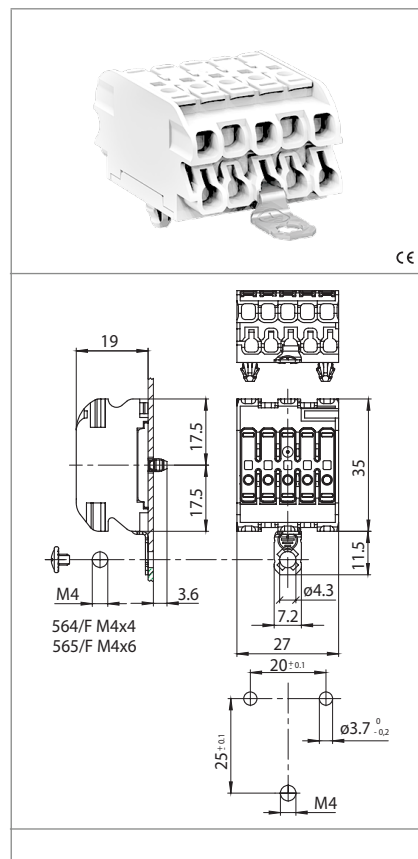

- Poli - Poles	4P+E
- Corrente e tensione nominale - Rated current and voltage	24A-450V
- Temperatura massima di funzionamento (IEC) - Maximum operating temperature (IEC)	T85
- Grado di protezione - Protection index	IP20

Caratteristiche

Characteristics

- Corpo in policarbonato bianco
- White polycarbonate body
- Corpo serrafilo in rame/acciaio stagnato
- Internal part in tin plated copper/steel
- Connessione di terra in acciaio zincato
- Earth connection in zinc plated steel



 fissaggio ad innesto push-in fixing	 spessore lamiera di fissaggio fixing metal plate thickness 0,4-1,25	 entrata: automatico uscita: automatico input side: push wire output side: push wire	 serrafilo automatico a 2 fori push-wire terminals with 2 holes
 sezione conduttore cordato e solido stranded and solid conductor section 1,5-2,5 mm ² 0,5-2,5	 spelatura cavetti cordati, solidi e flessibili stranded, solid and flexible wires stripping 9-10	 sezione conduttore cordato solido e flessibile stranded, solid and flexible conductor section 0,5-2,5 mm ²	 spelatura cavetti wires stripping 9-10
		 564/F M4x4 565/F M4x6	

Marchi di qualità

Quality marks

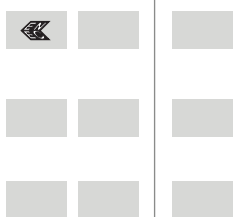

Direttive Europee

European directives

Conforme "RoHS"
"RoHS" compliant
Non soggetto alla "RAEE"
Not subject to "WEEE"

Pesi e confezioni

Weights and packaging

Art. Codice prodotti Product references	g Peso netto Net weight	n° pz per sacco per bag	n° pz per scatola per box	n° pz per cartone per carton
2675/A/43	15,4	500		

Note

Notes

Note

Note

SERRAFILO AUTOMATICO DEGLI ART. 2675/..

PUSH WIRE TERMINALS OF ART. 2675/...

