

**2675/A/43**

**VERBINDUNGSKLEMME FÜR LEUCHTENARMATUREN**  
**TERMINAL BLOCK FOR LIGHTING FIXTURES**

**Dati tecnici**

*Technical data*









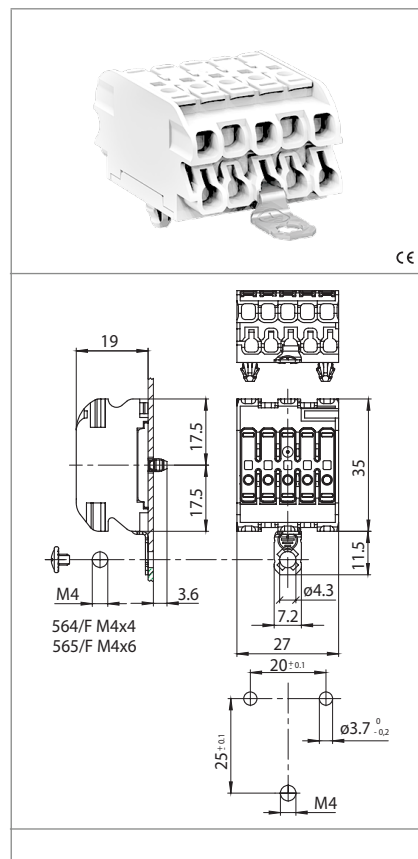

- Pole - Poles	4P+E
- Nennstrom und Nennspannung - Rated current and voltage	24A-450V
- Maximale Betriebstemperatur (IEC) - Maximum operating temperature (IEC)	T85
- Schutzgrad - Protection index	IP20

**Caratteristiche**

*Characteristics*

- Gehäuse aus polycarbonat, weiß  
- White polycarbonate body
- Innere Teile aus zinnbeschichtetem Kupferstahl  
- Internal part in tin plated copper/steel
- Erdung aus verzinktem Stahlblech  
- Earth connection in zinc plated steel



 Einteckbefestigung <i>push-in fixing</i>	 Blechstärke zur Befestigung <i>fixing metal plate thickness</i> 0,4-1,25	 Klemme eingang: Steckkontakt Klemme ausgang: Steckkontakt <i>input side: push wire output side: push wire</i>	 Steckkontakte mit 2 Löchern <i>push-wire terminals with 2 holes</i>
 Bereich starre und mehrdrige Leitungen <i>stranded and solid conductor section</i> 1,5-2,5 mm <sup>2</sup> 0,5-2,5	 Abisolierung, mehrdrige, starre und flexible Leitungen <i>stranded, solid and flexible wires stripping</i> 9-10	 Mehrdrige, massive und flexible Leitungsquerschnitt <i>stranded, solid and flexible conductor section</i> 0,5-2,5 mm <sup>2</sup>	
	 Leitungsabisolierung <i>wires stripping</i> 9-10	 564/F 565/F	

**Marchi di qualità**

*Quality marks*

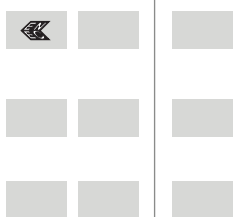

**Direttive Europee**

*European directives*

gemäß "RoHS"  
"RoHS" compliant  
unterliegt nicht "WEEE"  
Not subject to "WEEE"

**Pesi e confezioni**

*Weights and packaging*

Art. Codice prodotti Product references	g Peso netto Net weight	n° pz per sacco per bag	n° pz per scatola per box	n° pz per cartone per carton
2675/A/43	15,4	500		

**Note**

*Notes*

**Bemerkung**

Note

**SERRAFILO AUTOMATICO DEGLI ART. 2675/...**

**PUSH WIRE TERMINALS OF ART. 2675/...**

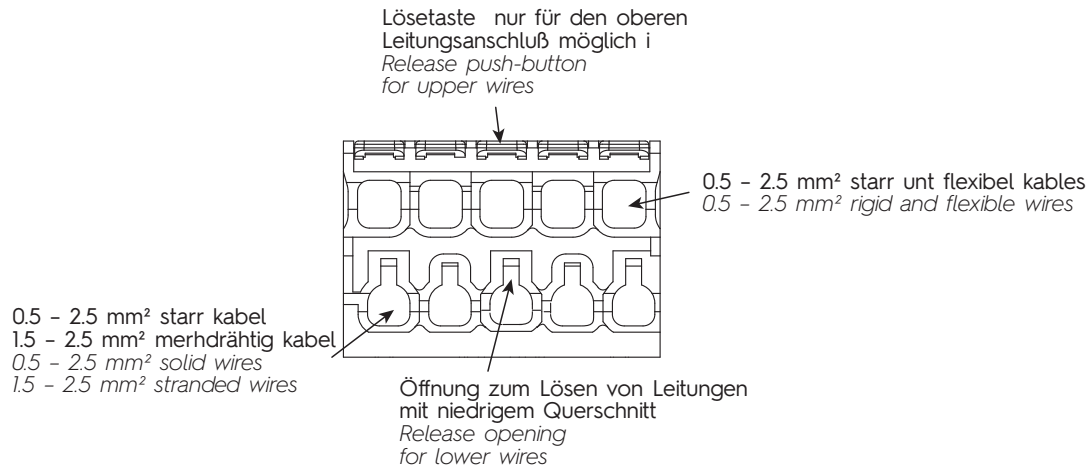

**Note**

*Note*

**SERRAFILO AUTOMATICO DEGLI ART. 2675/..**

**PUSH WIRE TERMINALS OF ART. 2675/...**

