

2675/A

MORSETTO PER APPARECCHI DI ILLUMINAZIONE TERMINAL BLOCK FOR LIGHTING FIXTURES

Dati tecnici

Technical data

| | |
|---|----------|
| - Poli - Poles | 4P+E |
| - Corrente e tensione nominale - Rated current and voltage | 24A-450V |
| - Temperatura massima di funzionamento (IEC) - Maximum operating temperature (IEC) | T85 |
| - Grado di protezione - Protection index | IP20 |





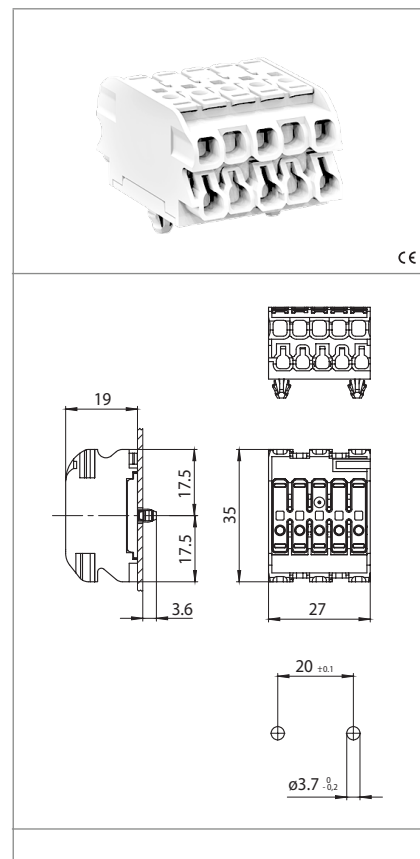

Caratteristiche

Characteristics

- Corpo in policarbonato bianco
– White polycarbonate body
- Corpo serrafilo in rame/acciaio stagnato
– Internal part in tin plated copper/steel

Per specifiche cavetti vedi info tecniche del capitolo
For wires' specs. see the chapter technical info



| | | | |
|---|--|---|---|
|  fissaggio ad innesto push-in fixing |  spessore lamiera di fissaggio fixing metal plate thickness 0,4-1,25 |  |  |
|  |  spelatura cavetti cordati, solidi e flessibili stranded, solid and flexible wires stripping 9-10 |  sezione conduttore cordato solido e flessibile stranded, solid and flexible conductor section 0,5-2,5 mm ² |  |
|  sezione conduttore cordato e solido stranded and solid conductor section 0,5-2,5 mm ² |  spelatura cavetti wires stripping 9-10 |  |  |

Marchi di qualità

Quality marks

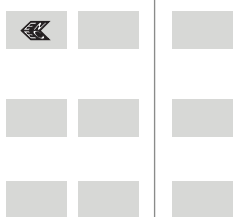

Direttive Europee

European directives

Conforme "RoHS"
"RoHS" compliant
Non soggetto alla "RAEE"
Not subject to "WEEE"

Pesi e confezioni

Weights and packaging

| Art. Codice prodotti Product references | g Peso netto Net weight | n° pz per sacco per bag | n° pz per scatola per box | n° pz per cartone per carton |
|---|-------------------------------|-------------------------------|---------------------------------|------------------------------------|
| 2675/A | 14,8 | | | 500 |
| | | | | |
| | | | | |
| | | | | |
| | | | | |
| | | | | |

Note

Notes

Note

Note

SERRAFILO AUTOMATICO DEGLI ART. 2675/..

PUSH WIRE TERMINALS OF ART. 2675/...

