

2675/A/42

MORSETTO PER APPARECCHI DI ILLUMINAZIONE
TERMINAL BLOCK FOR LIGHTING FIXTURES

Dati tecnici

Technical data

- Poli - Poles	4P+E
- Corrente e tensione nominale - Rated current and voltage	24A-450V
- Temperatura massima di funzionamento (IEC) - Maximum operating temperature (IEC)	T85
- Grado di protezione - Protection index	IP20





Caratteristiche

Characteristics

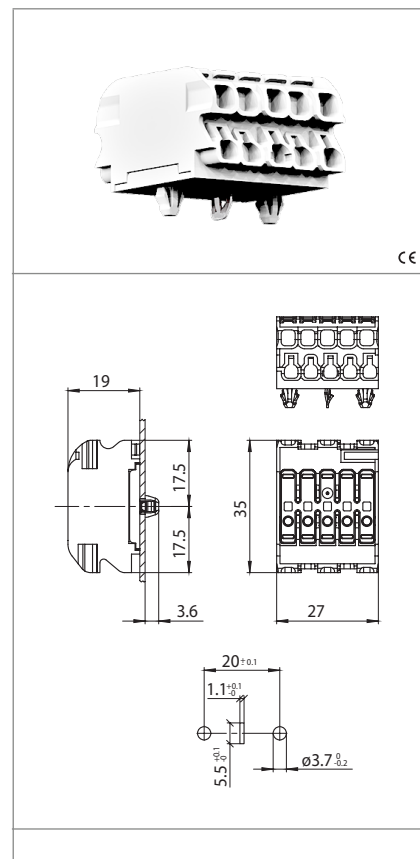
- Corpo in policarbonato bianco
- White polycarbonate body
- Corpo serrafilo in rame/acciaio stagnato
- Internal part in tin plated copper/steel
- Connessione di terra in bronzo
- Earth connection in bronze

Per specifiche cavetti vedi info tecniche del capitolo
For wires' specs. see the chapter technical info



 fissaggio ad innesto push-in fixing	 spessore lamiera di fissaggio fixing metal plate thickness 0,4-1,25	 sezione conduttore cordato e solido stranded and solid conductor section 1,5-2,5 mm ² 0,5-2,5	 spelatura cavetti wires stripping 9-10	 sezione conduttore cordato solido e flessibile stranded, solid and flexible conductor section 0,5-2,5 mm ²	
---	---	--	--	---	---

Marchi di qualità

Quality marks

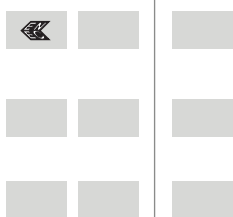

Direttive Europee

European directives

Conforme "RoHS"
"RoHS" compliant
Non soggetto alla "RAEE"
Not subject to "WEEE"

Pesi e confezioni

Weights and packaging

Art. Codice prodotti Product references	g Peso netto Net weight	n° pz per sacco per bag	n° pz per scatola per box	n° pz per cartone per carton
2675/A/42	15			500

Note

Notes

Note
Note

ISTRUZIONI DI MONTAGGIO

ASSEMBLING INSTRUCTIONS

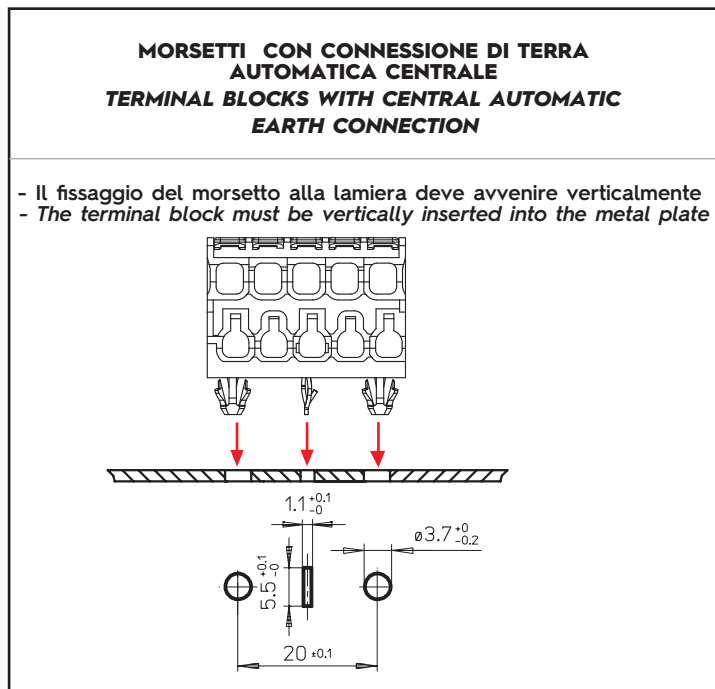

SERRAFILO AUTOMATICO DEGLI ART. 2675/...

PUSH WIRE TERMINALS OF ART. 2675/...

