

S-8000/14

**ADATTATORE PER RIFLETTORI LEDIL LENA E LENINA
ADAPTER FOR LENA AND LENINA REFLECTORS BY LEDIL**

Dati tecnici
Technical data

Caratteristiche
Characteristics

- Corpo in policarbonato bianco
- *White polycarbonate body*

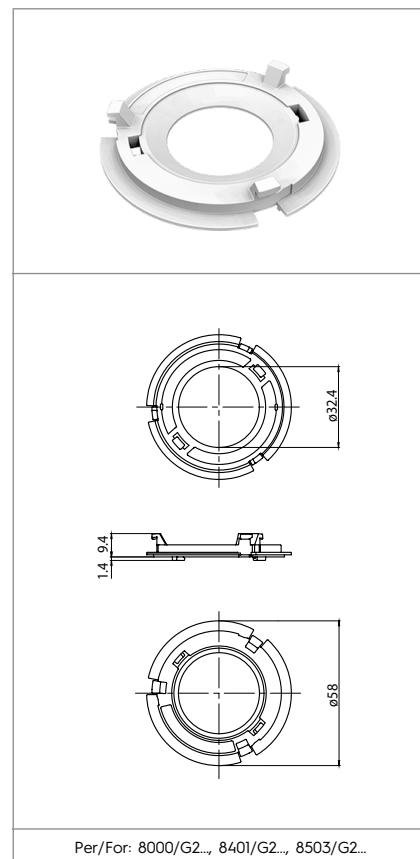

fissaggio ad innesto con rotazione
twist locking



Marchi di qualità
Quality marks

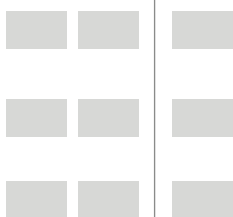

Direttive Europee
European directives

Conforme "RoHS"
"RoHS" compliant
Non soggetto alla "RAEE"
Not subject to "WEEE"

Pesi e confezioni
Weights and packaging

Art. Codice prodotti <i>Product references</i>	g Peso netto <i>Net weight</i>	n° pz per sacco <i>per bag</i>	n° pz per scatola <i>per box</i>	n° pz per cartone <i>per carton</i>
S-8000/14	4,1	200		

Note

Notes

Istruzioni

Instructions

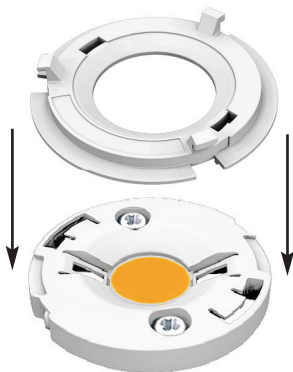

1) Inserire i denti di aggancio dell'adattatore nelle aperture previste negli holder per il fissaggio delle ottiche.

1) Insert the adapter's hooking pins into the holder's holes that are meant for the direct fixing of the reflectors.

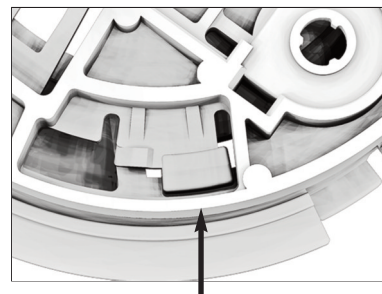
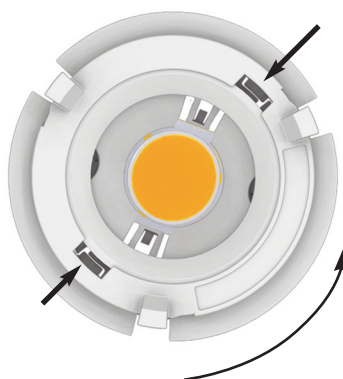

2) Ruotare l'adattatore fino alla posizione di blocco (superando il fermo anti-sganciamento).

2) Rotate the adapter till the locking position (going over the anti-releasing pin). The adapter is then correctly mounted into the holder.

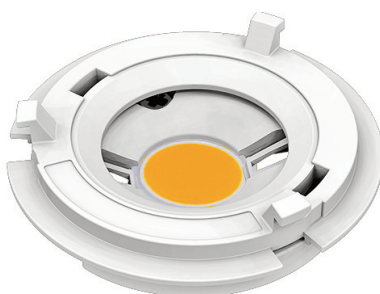

L'adattatore è correttamente assemblato sull'holder.
The adapter is then correctly mounted into the holder.



3) Inserire il riflettore centrando le tre apposite aperture sui denti di aggancio dell'adattatore e ruotarlo completamente fino alla posizione di riposo.

3) Insert the reflector truing up the three holes on the adapter's hooking pins. Rotate the reflector till it is in stroke end position.