

112

112/D

## PORTASTARTER CON DISTANZIATORE STARTERHOLDER WITH SPACING COLLAR

### Dati tecnici

Technical data





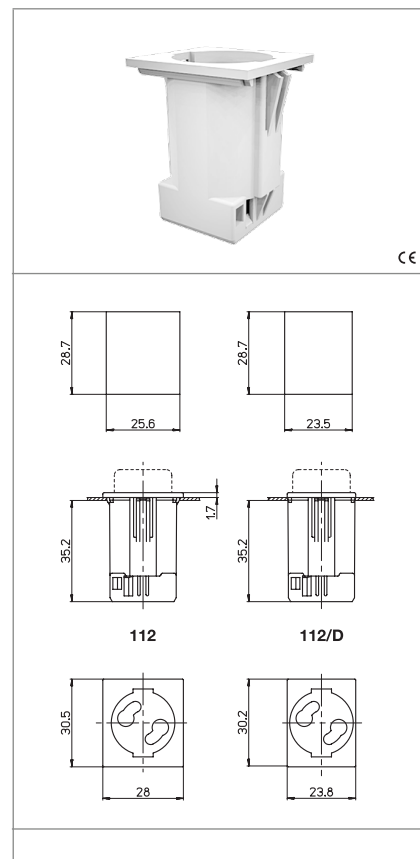

- Corrente e tensione nominale - Rated current and voltage	2A-250V
- Temperatura massima di funzionamento (IEC) - Maximum operating temperature (IEC)	T100
- Grado di protezione - Protection index	IP20
- Categoria di sovratensione - Impulse withstand category	III

### Caratteristiche

Characteristics

- Corpo in policarbonato bianco  
- White polycarbonate body
- Contatti in lega di rame  
- Copper alloy contacts



 fissaggio ad innesto snap-in fixing	 spessore lamiera di fissaggio fixing metal plate thickness 0,8 max	 serrafilo automatico ad 1 foro push-wire terminals with 1 hole	 sezione conduttori rigidi rigid conductor section 0,5-1 mm <sup>2</sup>
 spelatura cavetti rigidi rigid wires stripping 8-9	 IP40 nei punti d'aggancio IP40 in the hooking points		

### Marchi di qualità

Quality marks

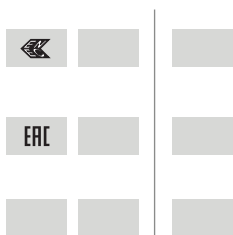

### Direttive Europee

European directives

Conforme "RoHS"  
"RoHS" compliant  
Non soggetto alla "RAEE"  
Not subject to "WEEE"

### Pesi e confezioni

Weights and packaging

Art. Codice prodotti Product references	g Peso netto Net weight	n° pz per sacco per bag	n° pz per scatola per box	n° pz per cartone per carton
112	7,3	500		
112/D	7	500		

### Note

Notes