

INFORMAZIONI TECNICHE/TECHNICAL INFO

CRYSTAL 070 H 50

PF070050-01-12385

PF070050-02-12385

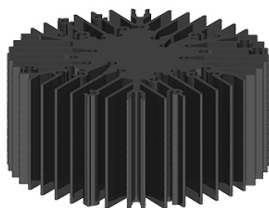

Clicca sull'immagine per visualizzarla in formato 3d.
Click on the image to see the 3D version.

Materiale: Alluminio Al6060
Finitura:
01. Anodizzato Nero
02. Anodizzato Silver
Diametro: 70 mm
Altezza: 50 mm
Peso: 223,6 g

Material: Aluminium Al6060
Finishing:
01. Anodized Black
02. Anodized Silver
Diameter: 70 mm
Height: 50 mm
Weight: 223,6 g

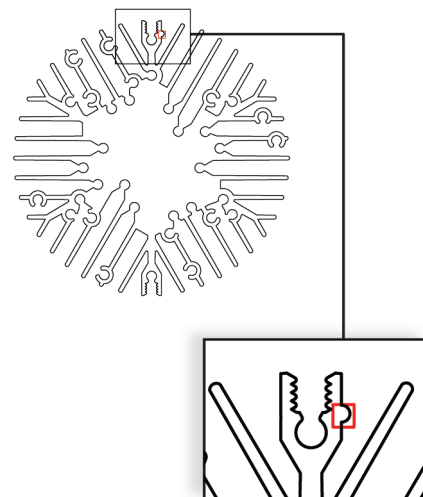

I dissipatori della serie Crystal sono dotati di un elemento identificativo per facilitare l'individuazione dei corretti fori di fissaggio da utilizzare. Lo "Zero Point" si ha con il dissipatore orientato come in figura con l'elemento identificativo posizionato a destra dell'aletta.

Crystal heat sinks are made with mounting holes for various LED sources/holders. To aid in the identification of the correct mounting holes for each application an indication tab is provided. Align this tab on the right of the fin, as pictured, to use the reference drawings.

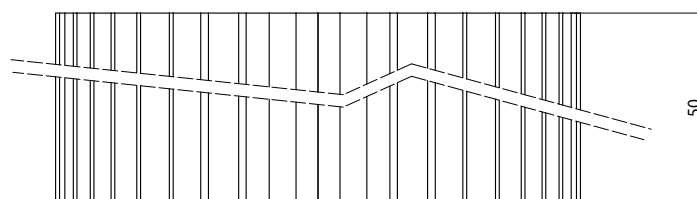
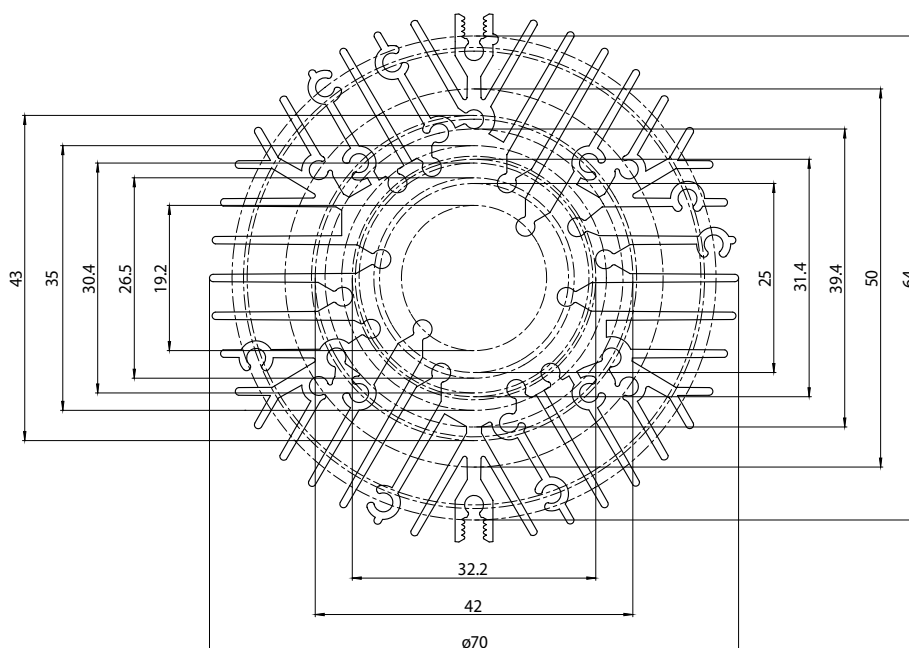

PERFORMANCE TERMICHE/THERMAL PERFORMANCES

CRYSTAL 070 H 50

DISSIPATORE IN ARIA LIBERA/OPEN AIR HEAT SINK



POSIZIONE DI LAVORO DISSIPATORE

Dissipatore posizionato con sorgente luminosa rivolta verso il basso.

HEAT SINK WORKING POSITION

Heat sink with downward light source.

APPLICAZIONE / APPLICATION: SPOTLIGHT

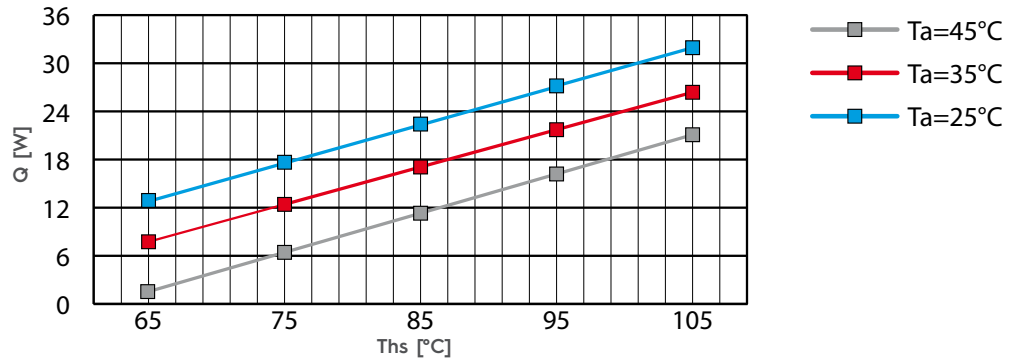
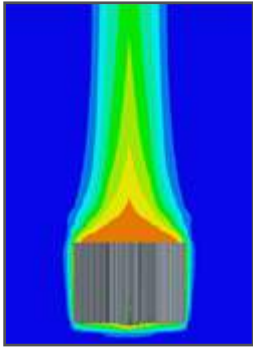

Per la corretta lettura del grafico vedi avvertenze. La potenza indicata nella tabella è quella termica da dissipare. La relazione tra potenza termica ed elettrica si trova nelle avvertenze. Nella tabella viene mostrata la temperatura Ths. Per il calcolo della relativa temperatura Tc va considerato anche lo specifico TIM utilizzato secondo l'equazione (1) illustrata nelle avvertenze.

Graphic reading instructions available in the warning section. The indicated power is related to the thermal power to be dissipated. The relation between thermal and electrical power is available in the warning section. The values in the table are referred to the Ths. In order to calculate the Tc value the presence of the TIM following the equation (1) in the warning section must be taken into consideration.

DISSIPATORE IN ARIA LIBERA/OPEN AIR HEAT SINK

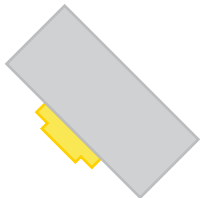

POSIZIONE DI LAVORO DISSIPATORE

Dissipatore posizionato con sorgente luminosa rivolta verso il basso a 45°.

HEAT SINK WORKING POSITION

Heat sink with downward, 45° light source.

APPLICAZIONE / APPLICATION: SPOTLIGHT

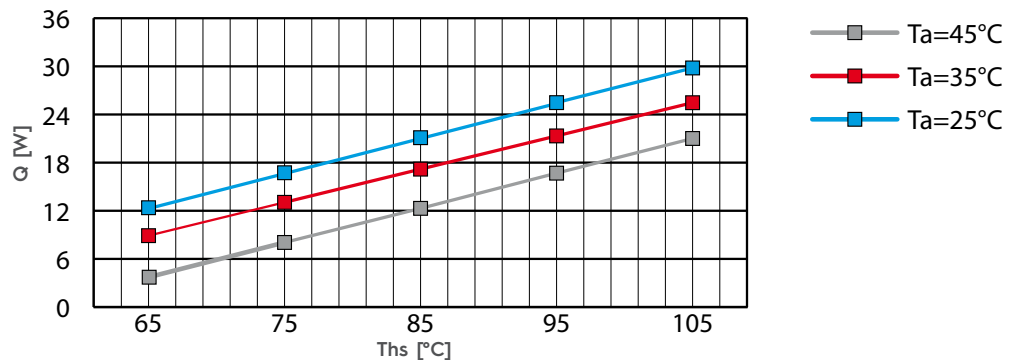
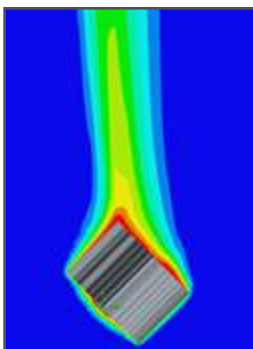

Per la corretta lettura del grafico vedi avvertenze. La potenza indicata nella tabella è quella termica da dissipare. La relazione tra potenza termica ed elettrica si trova nelle avvertenze. Nella tabella viene mostrata la temperatura Ths. Per il calcolo della relativa temperatura Tc va considerato anche lo specifico TIM utilizzato secondo l'equazione (1) illustrata nelle avvertenze.

Graphic reading instructions available in the warning section. The indicated power is related to the thermal power to be dissipated. The relation between thermal and electrical power is available in the warning section. The values in the table are referred to the Ths. In order to calculate the Tc value the presence of the TIM following the equation (1) in the warning section must be taken into consideration.



PERFORMANCE TERMICHE/THERMAL PERFORMANCES

CRYSTAL 070 H 50

DISSIPATORE ALL'INTERNO DELL'APPARECCHIO / HEAT SINK INSIDE THE LUMINAIRE

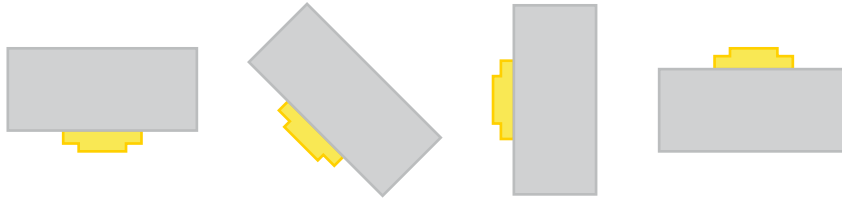

POSIZIONE DI LAVORO DISSIPATORE
Dissipatore posizionato con sorgente luminosa in diverse posizioni.

HEAT SINK WORKING POSITION
Heat sink with light source placed in different positions.

APPLICAZIONE / APPLICATION:
SPOTLIGHT

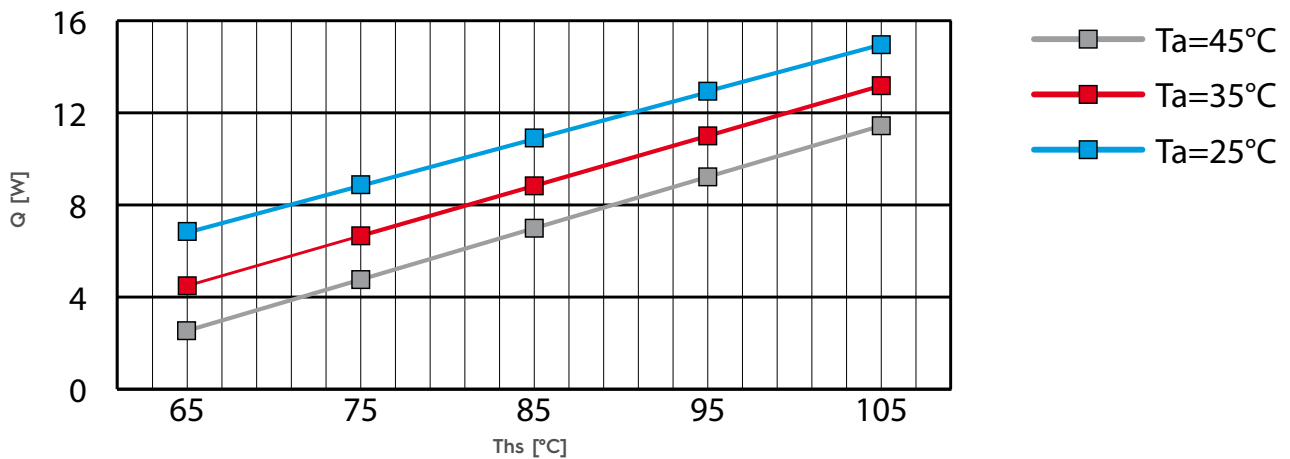
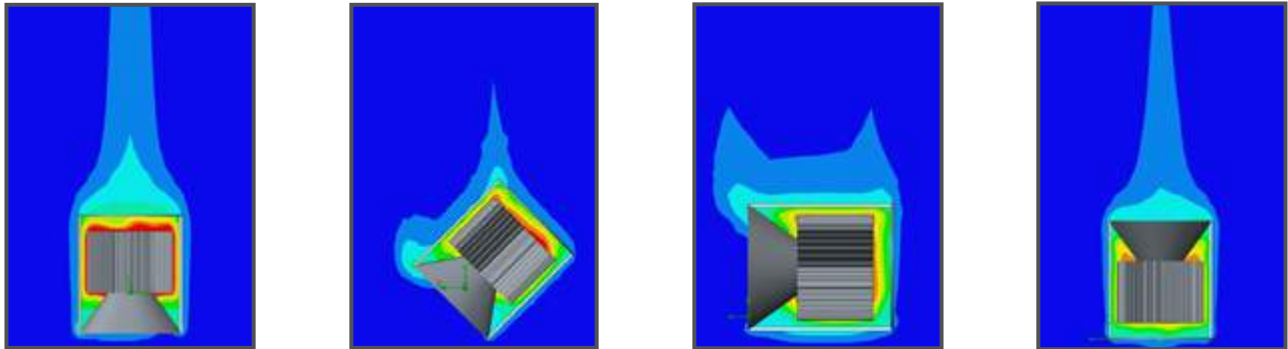

Per la corretta lettura del grafico vedi avvertenze. La potenza indicata nella tabella è quella termica da dissipare. La relazione tra potenza termica ed elettrica si trova nelle avvertenze. Nella tabella viene mostrata la temperatura Ths. Per il calcolo della relativa temperatura Tc va considerato anche lo specifico TIM utilizzato secondo l'equazione (1) illustrata nelle avvertenze. I dati si riferiscono ad un dissipatore posto in un apparecchio di illuminazione chiuso (tubo in alluminio lega Al6060) con riflettore in PC (H. 30 mm). Il dissipatore non è lateralmente a contatto con il tubo. Distanza tra dissipatore e fondo chiuso dell'apparecchio: 15 mm.

Graphic reading instructions available in the warning section. The indicated power is related to the thermal power to be dissipated. The relation between thermal and electrical power is available in the warning section. The values in the table are referred to the Ths. In order to calculate the Tc value the presence of the TIM following the equation (1) in the warning section must be taken into consideration. This data are referred to an heat sink placed into a closed luminaire (aluminium tube Al6060 alloy) with PC reflector (H. 30 mm). The heat sink is not in contact with the tube on the side. Distance between heat sink and closed bottom: 15 mm.



TABELLA FORI DI FISSAGGIO/FIXING HOLES TABLE

CRYSTAL 070 H 50

FISSAGGIO DEL DISSIPATORE / HEAT SINK FIXING

FISSAGGIO FRONTALE / FRONT FIXING



FISSAGGIO LATERALE / SIDE FIXING



○ : \varnothing 2.5
△ :2.5

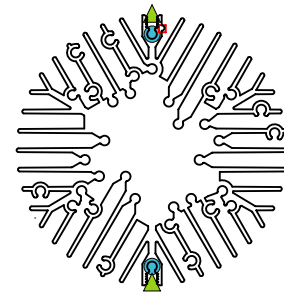

ACCESSORI / ACCESSORIES

BLOCCACAVO / CABLE LOCK



STAFFE IN PLASTICA / PLASTIC BRACKETS



STAFFE IN METALLO CON MOLLA / METAL BRACKETS WITH SPRING



○ : \varnothing 2.5
△ :2.5

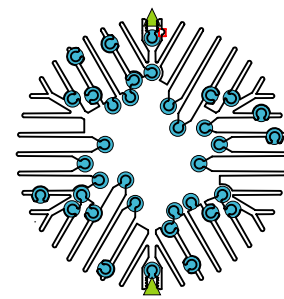

A.A.G. STUCCHI HOLDERS

PER COB / FOR COB

8100/G2; 8202/G2; 8400/G2; 8402/G2; 8500/G2; 8501/G2 *



8101/G2; 8102/G2; 8200/G2; 8201/G2; 8203/G2; 8301/G2; 8401/G2;



8403/G2; 8404/G2; 8503/G2 *

○ : \varnothing 2.5

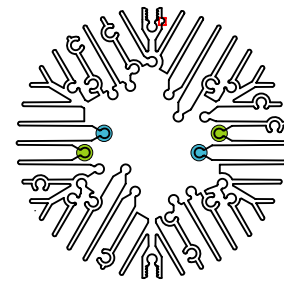

PER MODULI LED / FOR LED MODULES

7300 (ZHAGA BOOK 3 SPOT)



7500 (G46d "QUICKCHANGE"TM)



○ : \varnothing 2.5

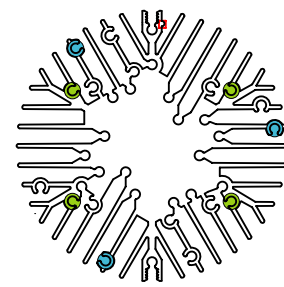

SORGENTI LUMINOSE / LIGHT SOURCES

BRIDGELUX

ES



VERO10



VERO13,18



VERO29



8102/G2 (V22)*



○ : \varnothing 2.5

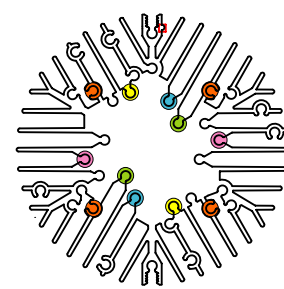

* Tutti gli Holder per COB LED A.A.G. Stucchi non sono disponibili per il mercato tedesco.
All A.A.G. Stucchi Holders for COB LEDs are not available for the German market.



TABELLA FORI DI FISSAGGIO/FIXING HOLES TABLE

CRYSTAL 070 H 50

CITIZEN ELECTRONICS

CLL022; CLU024,25,26,27,28; CLU700	●
CLL032; CLU034,36,38; CLU710; CLU720	●
CLL042; CLU044,46,48; CLU730	●
8100/G2 (CLL020,22; CLU024,25,26,27,28; CLU700)*	●
8101/G2 (CLL030,32; CLU034,36,38; CLU720);	●
8102/G2 (CLL040,42; CLU044,46,48)*	●

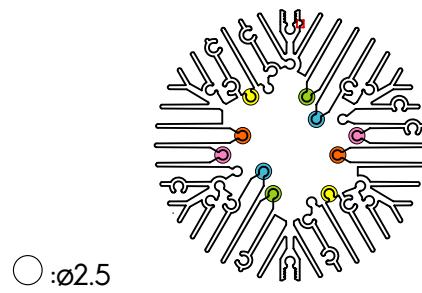

CREE

8402/G2 (CXA13; CXB13); 8400/G2 (CXA15; CXB15)*	●
8401/G2 (CXA25; CXB25); 8403/G2 (CXA18; CXB18);	●
8404/G2 (CXA30; CXB30)*	●

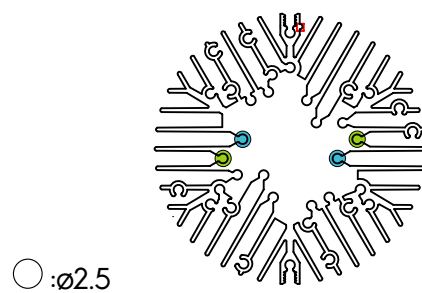

EDISON OPTO

EDIPOWER III HM 5,9,13W	●
EDIPOWER III HM 16,24,30W	●
EDIPOWER III HM 40W	●
8100/G2 (EDIPOWER III HM 5,9,13W)*	●
8101/G2 (EDIPOWER III HM 16,24,30W); 8102/G2 (EDIPOWER III HM 40W)*	●

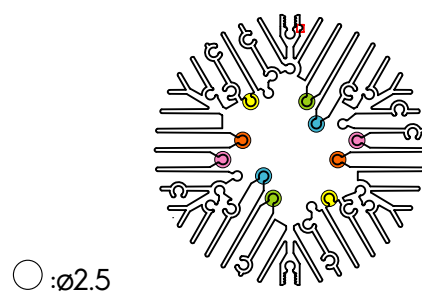

LEXTAR

NIMBUS 1500	●
8100/G2 (NIMBUS 1000)*	●
8102/G2 (NIMBUS 2000,3000,5000)*	●

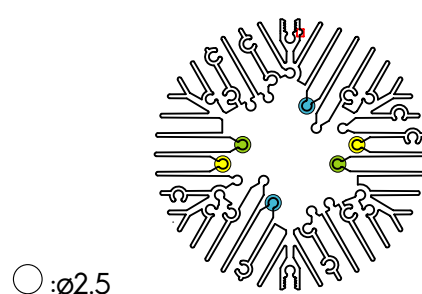

LG INNOTEK

8102/G2 (40W)*	●
----------------	---

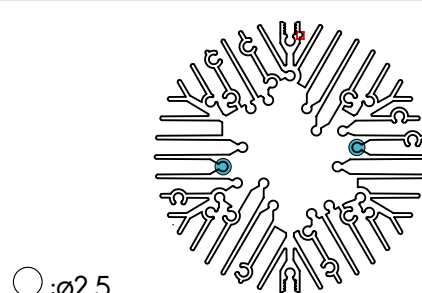

*Tutti gli Holder per COB LED A.A.G. Stucchi non sono disponibili per il mercato tedesco.
All A.A.G. Stucchi Holders for COB LEDs are not available for the German market.



TABELLA FORI DI FISSAGGIO/FIXING HOLES TABLE

CRYSTAL 070 H 50

LUMENS

8400/G2 (ERGON 15XX)*
8401/G2 (ERGON 25XX); 8403/G2 (ERGON 18XX); 8404/G2 (ERGON 30XX)*

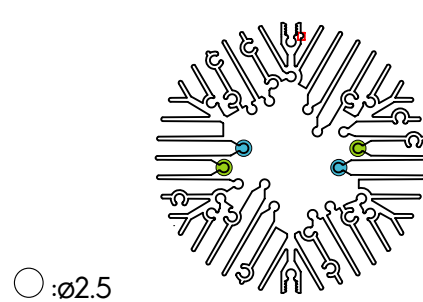

○:ø2.5

LUMILEDS

LUXEON 1202,1203
LUXEON 1204,1205,1208
LUXEON 1211,1212,1216
8102/G2 (LUXEON 1211,1212,1216); 8301/G2 (LUXEON 1204,1205,1208)*

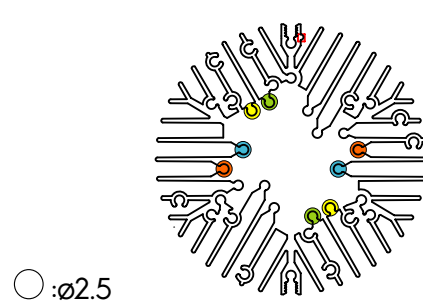

○:ø2.5

LUMINUS

XNOVA CHM9 AC00, XNOVA CLM9, XNOVA CXM9AC00
XNOVA CHM18
XNOVA CHM14 AC00, XNOVA CXM14 AC00
XNOVA CHM27, XNOVA CXM27
8100/G2 (XNOVA CHM9 AC00, XNOVA CLM9, XNOVA CXM9AC00)*
8101/G2 (XNOVA CHM14 AC00, XNOVA CXM14 AC00)*

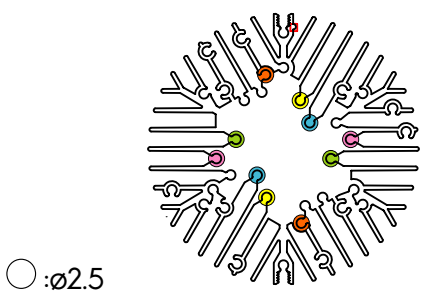

○:ø2.5

OSRAM OPTO SEMICONDUCTORS

SOLERIQ S9
SOLERIQ P13, S13, S19
8500/G2 (SOLERIQ P6); 8501/G2 (SOLERIQ P9); 8100/G2 (SOLERIQ S9)*
8101/G2 (SOLERIQ S13 19X19); 8503/G2 (SOLERIQ S19)*

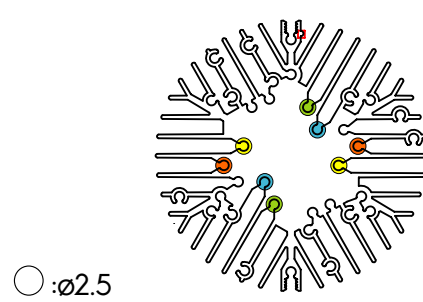

○:ø2.5

PANASONIC

8100/G2 (LUGA C 2015 DMC112)*
8101/G2 (LUGA C 2015 DMC104,115,118); 8102/G2 (LUGA 2015 C DMC11C,16C)*

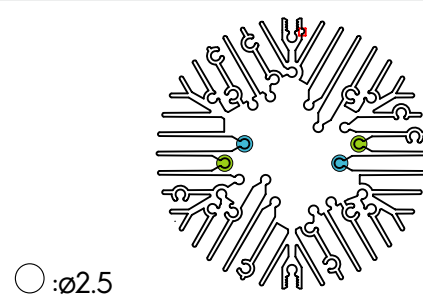

○:ø2.5

* Tutti gli Holder per COB LED A.A.G. Stucchi non sono disponibili per il mercato tedesco.
All A.A.G. Stucchi Holders for COB LEDs are not available for the German market.



TABELLA FORI DI FISSAGGIO/FIXING HOLES TABLE

CRYSTAL 070 H 50

SAMSUNG

LC06B,08B	●
LC013B,019B	●
LC026B,033B,040B	●
8202/G2 (LC06B,LC08B); 8200/G2 (LC013B); 8201/G2 (LC026,033B,040B); 8203/G2 (LC019B) *	●

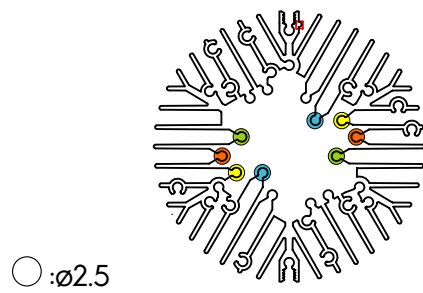

SEOUL SEMICONDUCTORS

ZC4,6	●
ZC12,18	●
ZC25,40,60	●
8100/G2 (ZC4,6) *	●
8101/G2 (ZC12,18); 8102/G2 (ZC25,40,60) *	●

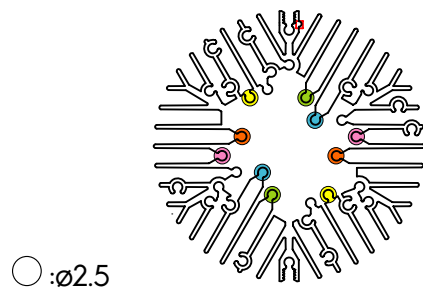

SHARP

8301/G2 (MEGAZENIGATA) *	●

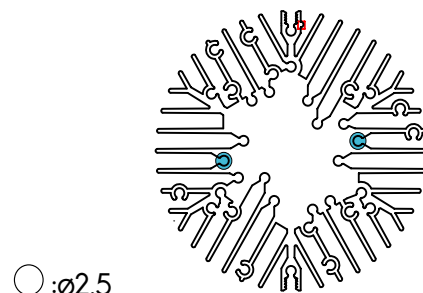

TOYODA GOSEI

7500 (G46d "QUICKCHANGE"™)	●

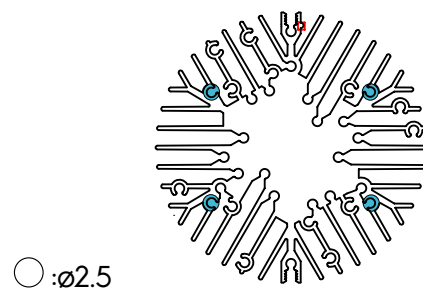

TRIDONIC

SLE LES6 (GEN.5); STARK LES10 (GEN.5); SLE LES11 (GEN.5)	●
SLE LES15 (GEN.5)	●
SLE LES17 (GEN.5)	●
SLE LES19 (GEN.5); SLE LES23 (GEN.5)	●
8100/G2 (SLE LES6 (GEN.5); STARK LES10 (GEN.5); SLE LES11 (GEN.5)) *	●
8101/G2 (SLE LES15 - GEN.5) *	●

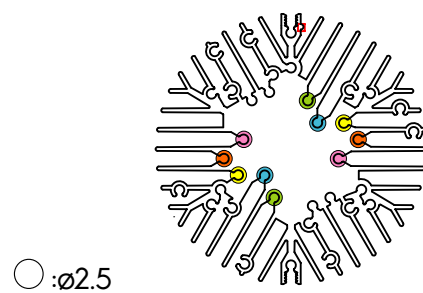

* Tutti gli Holder per COB LED A.A.G. Stucchi non sono disponibili per il mercato tedesco.
All A.A.G. Stucchi Holders for COB LEDs are not available for the German market.



TABELLA FORI DI FISSAGGIO/FIXING HOLES TABLE

CRYSTAL 070 H 50

XICATO

XTM

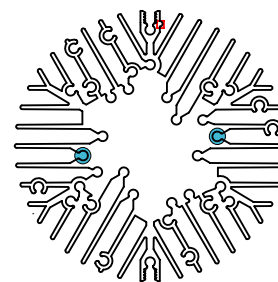

○ : \varnothing 2.5

MODULI ZHAGA / ZHAGA MODULES

BOOK 3 SPOT

BOOK 3 SPOT

BOOK 11 SPOT

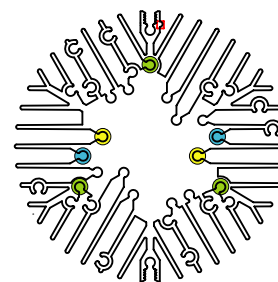

○ : \varnothing 2.5

* Tutti gli Holder per COB LED A.A.G. Stucchi non sono disponibili per il mercato tedesco.
All A.A.G. Stucchi Holders for COB LEDs are not available for the German market.

ACCESSORI/ACCESSORIES



HB5/N

Staffa corta in plastica

Short plastic bracket



HB10/N

Staffa lunga in plastica

Long plastic bracket



HC18/N

Bloccacavo

Cable lock



HSB90

Staffa corta in metallo con molla

Short metal bracket with spring



HSB125

Staffa lunga in metallo con molla

Long metal bracket with spring



AVVERTENZE/WARNING

CRYSTAL 070 H 50

Il dissipatore è un componente che permette lo smaltimento del calore emesso dalle sorgenti luminose LED.

Il punto più caldo nel LED si trova in corrispondenza della giunzione dove è fondamentale che non venga superato il valore limite di temperatura imposto dal costruttore (Tj).

Poiché però la Tj è difficilmente misurabile, il costruttore del LED indica anche un punto alternativo sulla superficie del LED dove rilevare la temperatura Tc (temperatura del corpo LED) che rappresenta quindi la temperatura massima di funzionamento del LED.

Il LED deve essere montato sul dissipatore e lavorare secondo le istruzioni date dal produttore.

Tra la superficie del LED ed il dissipatore deve essere previsto l'utilizzo di un materiale di interfaccia termica (TIM) per garantire il corretto andamento del flusso termico.

La funzione del TIM è di riempire gli spazi creati dalla rugosità delle due superfici a contatto fra loro (LED e dissipatore), eliminando l'aria, che è un isolante termico.

Inoltre per facilitare la dissipazione del calore, deve essere favorita la naturale ventilazione del dissipatore evitando eventuali ostacoli e l'utilizzo in ambienti troppo ristretti.

I produttori di apparecchi di illuminazione hanno la responsabilità di verificare l'idoneità del dissipatore per il loro uso specifico e per le applicazioni previste.

CALCOLO DELLA TEMPERATURA Tc PARTENDO DAL VALORE DATO Ths (TEMPERATURA DEL DISSIPATORE):

La temperatura Tc indicata dal costruttore è influenzata dalla presenza del TIM.

Ogni TIM è caratterizzato da una propria resistenza termica Rth TIM che può variare notevolmente ed è strettamente legata al materiale di cui è costituito, alla superficie e allo spessore.

Secondo l'equazione (1) è possibile calcolare il corretto valore della Tc a partire dal valore della Ths:

$$T_c = T_{hs} + R_{th\ TIM} * Q \quad (1)$$

E analogamente:

$$T_{hs} = T_c - R_{th\ TIM} * Q \quad (2)$$

Dove:

- Ths [°C] = temperatura del dissipatore misurata sulla superficie a contatto con il TIM;

- Rth TIM [°C/W] = resistenza termica dell'interfaccia termica che viene calcolata secondo:

$$R_{th\ TIM} = sp / (S * k) \quad (3)$$

- sp [m] = spessore del TIM;

- S [m²] = superficie del TIM;

- k [W/m°C] = coefficiente di scambio conduttivo del TIM dichiarata dal costruttore.

- Q [W] = potenza termica del LED da dissipare.

Va ricordato che non tutta la potenza elettrica del LED si trasforma in potenza termica da dissipare. A seconda dell'efficienza delle sorgenti LED (η_{LED}) si avrà una percentuale di potenza che deve essere considerata nella scelta dei dissipatori:

$$Q = (1 - \eta_{LED}) * P_{el} \quad (4)$$

Heat sinks are devices to dissipate the heat emitted by LED lights. The hottest point in a LED is to be found at the junction, where it is compulsory that the temperature does not exceed the limit stated by the manufacturer (Tj).

Since it is very difficult measuring the Tj directly, manufacturers give a different point, the Tc (Case Temperature), which then constitutes the highest operating temperature of the LED.

The LED must be installed and work in accordance with the manufacturer's guidelines.

In order to ensure the correct flow of the heat, a Thermal Interface Material (TIM) must be placed between the surface of the LED and the heat sink.

The TIM fills in the gaps between surfaces of the LED and heat sink, thus displacing the air, which is a thermal insulator.

In order to ensure maximum heat dissipation, the natural flow of the air over the heat sink must be optimized, i.e. by avoiding installation in narrow spaces or avoiding obstacles.

Lighting manufacturers must duly check the adequacy of the heat sink for their specific and intended applications.

HOW TO CALCULATE THE Tc, BASED ON THE GIVEN Ths (HEAT SINK TEMPERATURE):

The Case Temperature Tc stated by the manufacturer is highly affected by the presence of a TIM.

Each TIM has a different thermal resistance Rth TIM, which may vary considerably and highly depending on the material of which the TIM is made, on its shape and thickness.

The following equation (1) allows to calculate the exact Tc on the basis on Ths:

$$T_c = T_{hs} + R_{th\ TIM} * Q \quad (1)$$

And similarly:

$$T_{hs} = T_c - R_{th\ TIM} * Q \quad (2)$$

Whereas:

- Ths [°C] = temperature of the surface of the heat sink, which is in contact with the TIM;

- Rth TIM [°C/W] = thermal resistance of the thermal interface, calculated as follows:

$$R_{th\ TIM} = sp / (S * k) \quad (3)$$

- sp [m] = TIM thickness;

- S [m²] = TIM surface;

- k [W/m°C] = TIM thermal conductivity as stated by the manufacturer.

- Q [W] = LED thermal power to be dissipated.

Please note that not all electric power emitted by a LED is converted into thermal power. A different percentage of power must be taken into account when choosing a heat sink depending on the efficiency of LED light sources (η_{LED}).

$$Q = (1 - \eta_{LED}) * P_{el} \quad (4)$$



Esempio:

P_{el} [W]	$\eta_{LED}=15\%$ Q [W]	$\eta_{LED}=17\%$ Q [W]	$\eta_{LED}=20\%$ Q [W]
4,6	3,91	3,81	3,68

Example:

INFLUENZA DELLA TEMPERATURA AMBIENTE:

Un parametro che influenza le performance di un dissipatore è la temperatura ambiente in cui il dissipatore lavora. Secondo l'equazione:

$$Q = (T_c - T_a) / R_{hs} \quad (5)$$

Dove:

- Q [W] = potenza termica dissipata dal dissipatore;
- R_{hs} [°C/W] = resistenza del dissipatore e del TIM;
- T_c [°C] = temperatura del corpo LED indicata dal costruttore;
- T_a [°C] = temperatura ambiente.

INFLUENZA DELLA POSIZIONE DI LAVORO DEL DISSIPATORE:

L'inclinazione influisce sulla capacità dell'aria che circonda il dissipatore di fluire nelle cavità delle alette e di sottrarre potenza termica al dissipatore per disperderla in ambiente. La diversa inclinazione del corpo quindi è un parametro che influisce sulle performance del dissipatore.

Esempio:

Dati forniti dal produttore LED:

$T_c \max = 85$ °C , potenza elettrica= 10 W , efficienza LED= 17%.

Dati forniti dal produttore del TIM:

$R_{th} \text{ TIM} = 0.5$ °C/W.

Condizioni al contorno:

$T_{ambiente} = 35$ °C, dissipatore in aria libera, posizionato con sorgente luminosa rivolta verso il basso.

Potenza termica da dissipare:

$$Q = (1 - \eta_{LED}) * P_{el} = (1 - 0.17) * 10 = 8.3 \text{ W}$$

$$T_{hs} = T_c - R_{th} \text{ TIM} * Q = 85 - 0.5 * 8.3 = 80.85 \text{ °C}$$

Guardando i valori riportati nei grafici di questa scheda tecnica è possibile dimensionare correttamente il dissipatore per le specifiche esigenze.

Sul grafico vengono riportate tre differenti temperature ambiente tra cui scegliere.

Nell'esempio:

$$\begin{aligned} Q &= 8.3 \text{ W} \\ T_{hs} &= 80.85 \text{ °C} \\ T_a &= 35 \text{ °C} \end{aligned}$$

Entrando nel grafico del dissipatore di interesse con i dati calcolati si può procedere con la verifica di dimensionamento per le performance richieste.

INFLUENCE OF AMBIENT TEMPERATURE:

A parameter that affects the performance of a heat sink is the ambient temperature in which it operates, calculated as follows:

$$Q = (T_c - T_a) / R_{hs} \quad (5)$$

Whereas:

- Q [W] = thermal power dissipated by the heat sink;
- R_{hs} [°C/W] = resistance of the heat sink and of the TIM;
- T_c [°C] = temperature of the LED stated by the manufacturer;
- T_a [°C] = ambient temperature.

INFLUENCE OF THE HEAT SINK WORKING POSITION:

The angle of inclination affects the air flow through the fins, thus influencing the flow of the air to lower the thermal power of the heat sink and disperse it in the surrounding space. Therefore, a different working position angle is a parameter affecting the performance of the heat sink.

Example:

From the LED manufacturer data sheet:

$T_c \max = 85$ °C , electric power= 10 W , LED efficiency= 17%.

From the TIM manufacturer data sheet:

$R_{th} \text{ TIM} = 0.5$ °C/W.

Conditions in the surrounding space:

$T_{ambient} = 35$ °C, heat sink is placed in a free air flow, with the light source downwards.

Thermal power to be dissipated:

$$Q = (1 - \eta_{LED}) * P_{el} = (1 - 0.17) * 10 = 8.3 \text{ W}$$

$$T_{hs} = T_c - R_{th} \text{ TIM} * Q = 85 - 0.5 * 8.3 = 80.85 \text{ °C}$$

Verifying the data in the graphic here below, it is possible to shape the heat sink with the correct dimension depending on the different needs.

The chart shows three different room temperatures to choose from.

In the example:

$$\begin{aligned} Q &= 8.3 \text{ W} \\ T_{hs} &= 80.85 \text{ °C} \\ T_a &= 35 \text{ °C} \end{aligned}$$

Seeing the graphic referring to the heat sink in use with the relevant data it is possible to verify which size best suits the performance needed.



CRYSTAL 45

Altezza/Height: 50 mm
Orientamento/Orientation: 0°

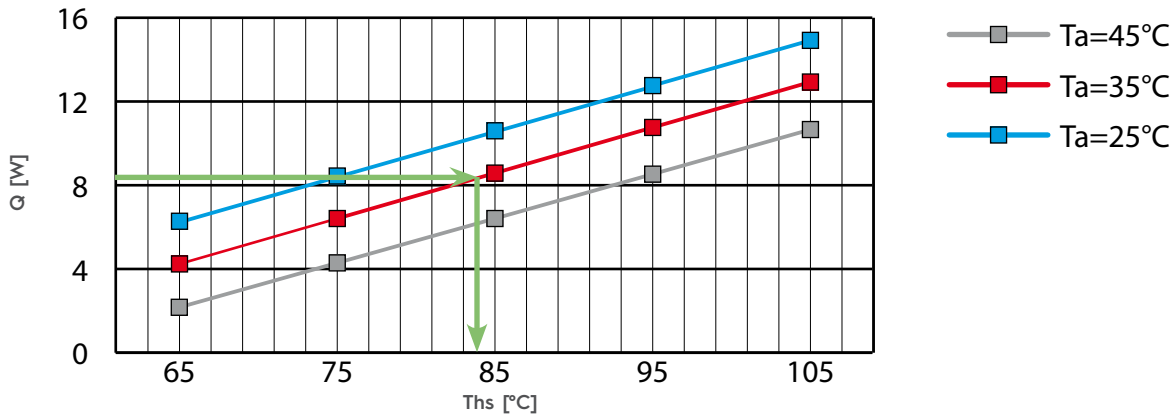

Come si evince dal grafico il dissipatore scelto non è sufficiente per soddisfare le richieste.

The graphic shows that the chosen heat sink is not suitable to meet the specific needs.

Cambiando l'altezza del dissipatore e consultando il grafico corrispondente è possibile trovare il dissipatore correttamente dimensionato.

Modifying the height of the heat sink, and going through the chart the most suitable heat sink can easily be determined.

CRYSTAL 45

Altezza/Height: 80 mm
Orientamento/Orientation: 0°

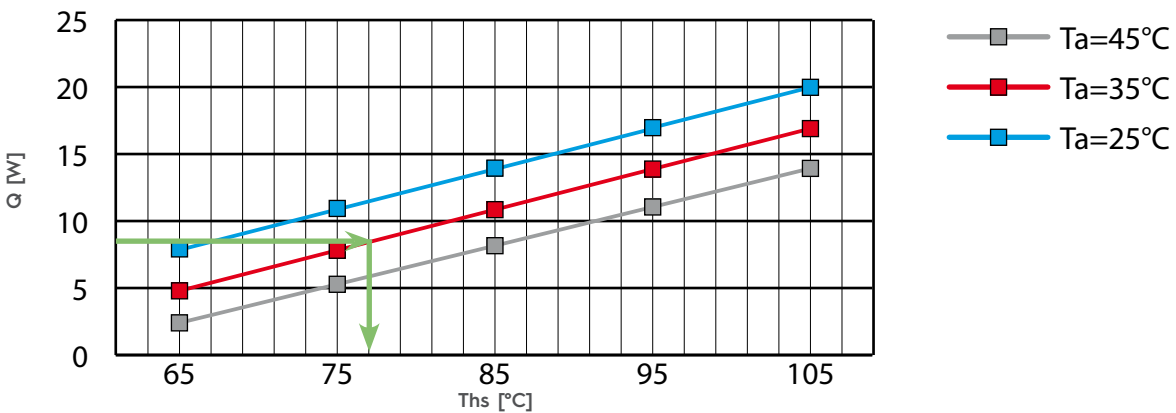

Maggiori informazioni sulla dissipazione termica, sulle potenze e sulle resistenze termiche in differenti condizioni di utilizzo sono fornite su richiesta.

More information regarding thermal dissipation, thermal power and resistance for applications in different conditions are available on request.

AVVERTENZE: I valori indicati si riferiscono al comportamento dei dissipatori in specifiche condizioni ambientali: assenza di moti d'aria, ambiente a umidità relativa e Ta controllati.

PLEASE NOTE: The values shown in all charts refer to the performance of heat sinks in a controlled environment, i.e. in the absence of air streams, controlled relative humidity and Ambient Temperature.

Le prestazioni dei dissipatori variano con le condizioni operative. Sono disponibili dissipatori in varie forme per tutti i tipi di sorgente luminosa LED.

Performance of heat sinks vary depending on operating conditions. We can provide heat sinks with different shapes and finishes for all kinds of LED light sources.

Possibilità di lavorazioni meccaniche addizionali a richiesta.

We can provide additional machining on demand.

Possibilità di sviluppo di progetti ad hoc sulla base di campioni o disegni.

We can develop tailor-made projects, based on samples or drawings provided by our clients.

Supporto tecnico nella fase progettuale dell'apparecchio di illuminazione anche grazie all'ausilio di un software di simulazione termica.

We can provide technical support in the designing process, thanks to a thermal simulation software.

