

16/V

## PORTASTARTER STARTERHOLDER

### Dati tecnici

Technical data





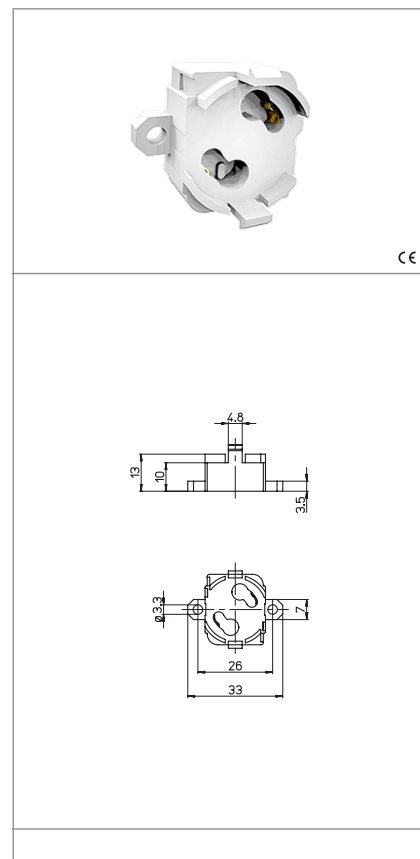

- Corrente e tensione nominale - <i>Rated current and voltage</i>	2A-250V
- Temperatura massima di funzionamento (IEC) - <i>Maximum operating temperature (IEC)</i>	T110
- Grado di protezione - <i>Protection index</i>	IP20
- Categoria di sovratensione - <i>Impulse withstand category</i>	III

### Caratteristiche

Characteristics

- Corpo in policarbonato bianco  
- *White polycarbonate body*
- Contatti in lega di rame  
- *Copper alloy contacts*



 fissaggio con vite <i>screw fixing</i>	 spessore <i>thickness</i>	 serrafilo automatico ad 1 foro <i>push-wire terminals with 1 hole</i>	 sezione conduttori rigidi <i>rigid conductor section</i>
 spelatura cavetti rigidi <i>rigid wires stripping</i>	 IP40 nei punti d'aggancio <i>IP40 in the hooking points</i>		

### Marchi di qualità

Quality marks



### Direttive Europee

European directives

Conforme "RoHS"  
"RoHS" compliant  
Non soggetto alla "RAEE"  
Not subject to "WEEE"

### Pesi e confezioni

Weights and packaging

Art. Codice prodotti <i>Product references</i>	g Peso netto <i>Net weight</i>	n° pz per sacco <i>per bag</i>	n° pz per scatola <i>per box</i>	n° pz per cartone <i>per carton</i>
16/V	3,6	1000	500	

### Note

Notes