

111

111/AU

## PORTASTARTER STARTERHOLDER

### Dati tecnici

Technical data







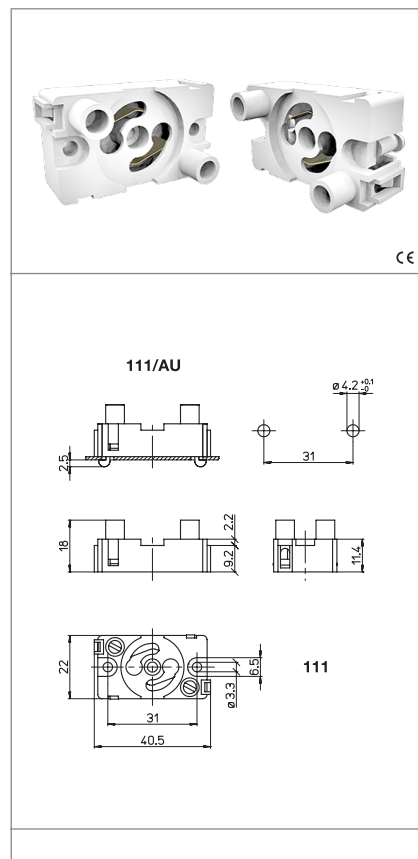

- Corrente e tensione nominale - <i>Rated current and voltage</i>	2A-250V
- Temperatura massima di funzionamento (IEC) - <i>Maximum operating temperature (IEC)</i>	
- Grado di protezione - <i>Protection index</i>	IP20
- Categoria di sovratensione - <i>Impulse withstand category</i>	III

### Caratteristiche

Characteristics

- Corpo in policarbonato bianco  
- *White polycarbonate body*
- Contatti in ottone  
- *Brass contacts*



 fissaggio con vite <i>screw fixing</i>	 fissaggio ad innesto <i>push-in fixing</i>	 spessore lamiera di fissaggio <i>fixing metal plate thickness</i>	 spessore <i>thickness</i>
 serrafilo con vite e morsetto <i>screw terminals</i>	 sezione conduttore flessibile <i>flexible conductor section</i>	 sezione conduttori rigidi <i>rigid conductor section</i>	 spelatura cavetti rigidi e flessibili <i>rigid and flexible wires stripping</i>

### Marchi di qualità

Quality marks

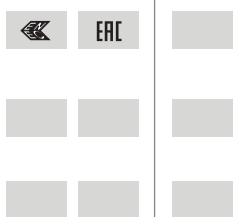

### Direttive Europee

European directives

Conforme "RoHS"  
"RoHS" compliant  
Non soggetto alla "RAEE"  
Not subject to "WEEE"

### Pesi e confezioni

Weights and packaging

Art. Codice prodotti <i>Product references</i>	g Peso netto <i>Net weight</i>	n° pz per sacco per bag	n° pz per scatola per box	n° pz per cartone per carton
111	7	1000		
111/AU	7		200	

### Note

Notes