

9209/BD-M-B

9209/BD-M-W

BOX DRIVER PER ADATTATORE ASIMMETRICO
LED DRIVER BOX FOR ASYMMETRIC ADAPTER

Dati tecnici

Technical data









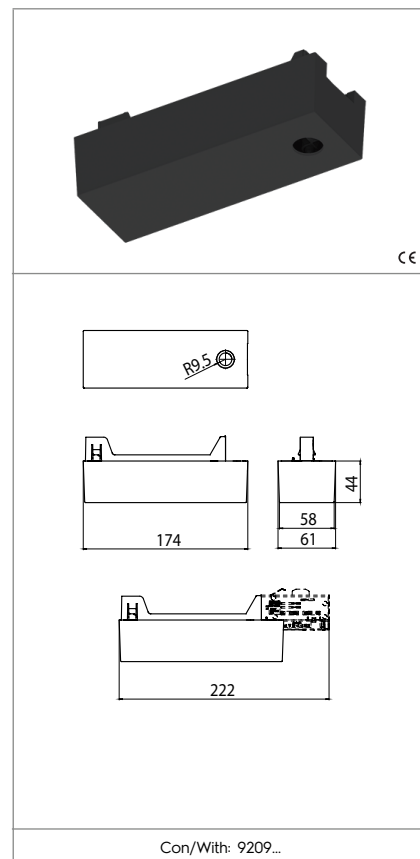



Caratteristiche

Characteristics

- Corpo in policarbonato. Colori disponibili: nero RAL9005 (B) e bianco RAL9010 (W)
- Polycarbonate body. Available colours: black RAL9005 (B) and white RAL9010 (W)
- Dimensione massima per alloggiamento driver: 116x52x30 mm
- Maximum housing space for driver: 116x52x30 mm

Adattatore asimmetrico non incluso
Asymmetric adapter is not included



	 S-9209-	 S-9209-BD-	 S-9209-
 KIT-BD/M.			
			

Marchi di qualità

Quality marks

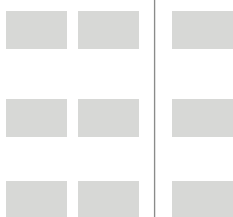

Direttive Europee

European directives

Conforme "RoHS"
"RoHS" compliant

Pesi e confezioni

Weights and packaging

Art. Codice prodotti Product references	g Peso netto Net weight	n° pz per sacco per bag	n° pz per scatola per box	n° pz per cartone per carton
9209/BD-M-B	129,3			
9209/BD-M-W	129,3			

Note

Notes

ATTENZIONE

Tutte le operazioni descritte in questo foglio di istruzioni devono essere eseguite da personale specializzato, escludendo tensione dall'impianto e rispettando le norme nazionali di installazione. A.A.G. Stucchi permette solo l'utilizzo dei componenti A.A.G. Stucchi all'interno delle applicazioni che utilizzano il sistema ONETRACK®. Questi componenti devono essere installati secondo le istruzioni di montaggio fornite dall'azienda. L'azienda, come produttrice, non è responsabile della sicurezza e del funzionamento del sistema in caso si utilizzino componenti non appartenenti ad esso o se le istruzioni di montaggio non venissero rispettate. È inoltre responsabilità dell'utente garantire la compatibilità elettrica, meccanica e termica tra il sistema ONETRACK® e gli apparecchi di illuminazione utilizzati. Il binario ed i suoi componenti, compresi gli adattatori, non sono intercambiabili con accessori che non riportino il Marchio di Qualità. Sul binario A.A.G. Stucchi è possibile utilizzare solo le connessioni A.A.G. Stucchi. Le connessioni A.A.G. Stucchi possono essere utilizzate solo su binari A.A.G. Stucchi. Durante il montaggio dei binari rispettare le distanze di ancoraggio e non superare i carichi indicati nella relativa sezione.

Il profilo del binario ha una chiave meccanica per rispettare il giusto collegamento tra gli spezzoni di binario.

Anche le testate ed i giunti di collegamento presentano una chiave meccanica (presenza vite - vedi figura sotto) che deve essere tenuta in considerazione per la scelta del giusto componente.

Nei disegni di catalogo di questi accessori il posizionamento della chiave meccanica è evidenziato da una linea rossa.

WARNING

All the described operations of this instructions page must be done by specialized personnel only. Exclude voltage plant. Please respect national installation regulations. A.A.G. Stucchi allows to use only A.A.G. Stucchi parts in applications where ONETRACK® system is used. These parts must be installed according to the installation instructions. The company as a manufacturer is not responsible for the safety and functioning of the system if parts not belonging to it are used or if any deviation from the installation instructions occurs. It is then the user's responsibility to ensure the electrical, mechanical and thermal compatibility between the system and the fixtures used with it. The track, its components and also the adapters can't be used with accessories without the Quality Mark. On A.A.G. Stucchi track one can use only A.A.G. Stucchi connections. A.A.G. Stucchi connections can be used only with A.A.G. Stucchi tracks. Do not exceed listed loading indicated in the relevant section and respect fixing distances during the track mounting.

There is a mechanical key on the outline of the track to guarantee the right connection of the multiple pieces of the track.

Also end-feeds and connection joints have a mechanical key (screw presence as per picture below) that must be taken into account in order to choose the right component.

In the catalogue sketches of this articles the position of the key is highlighted with a red line.

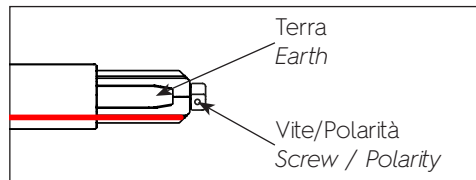

ISTRUZIONI DI MONTAGGIO BOX DRIVER

MOUNTING INSTRUCTIONS BOX DRIVER

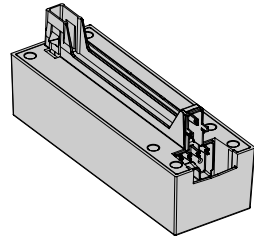

9209/BD-M...

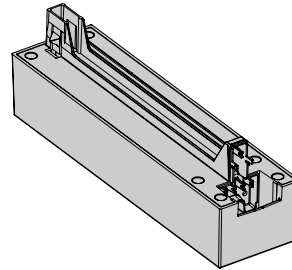

9209/BD-L...

