

## EPC1116

### PRESE DI CONNESSIONE CON COPERTURA E BLOCCACAVO (EP3FO) CONNECTION SOCKETS WITH COVER AND STRAIN RELIEF (EP3FO)

#### Dati tecnici

##### Technical data

- Poli - Poles	2P+E
- Corrente e tensione nominale - Rated current and voltage	20A-250V
- Temperatura massima di funzionamento (IEC) - Maximum operating temperature (IEC)	T100
- Grado di protezione - Protection index	IP20



a brand of  
**STUCCHI**

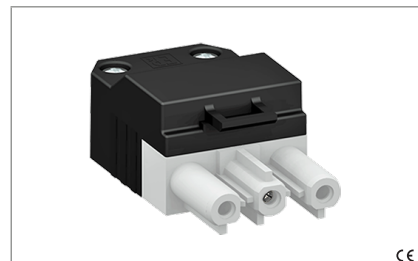

#### Caratteristiche







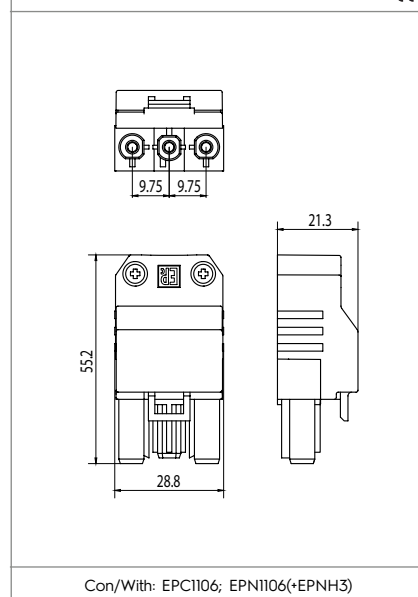

##### Characteristics

- Corpo in poliammide nera/grigia  
– Black/Grey polyamide body
- Contatti in ottone argentato  
– Silver plated brass contacts
- Marchiatura: N - T - L  
– Marking: N - E - L

\* Versione cURus a richiesta  
\* cURus version on demand



Con/With: EPC1106; EPN1106(+EPNH3)

 senza fissaggio without fixing	 fissaggio con vite screw fixing	 serrafilo con vite e morsetto screw terminals	 diametro conduttore flessibile con fascetta diameter of the flexible conductor with ferrule ø 2,7 max.
 sezione conduttore flessibile section of the flexible conductor 20A;1,5-2,5	 sezione conduttori rigidi rigid conductor section 20A;1,5-2,5	 spelatura cavetti rigidi e flessibili (con o senza fascetta) rigid and flexible wires stripping (with or without ferrule) 7	 protetto IP40 quando accoppiato IP40 protected when plugged in
 adatto per tensione di accensione ad impulsi fino a... suitable for impulse ignition voltage up to... 5kV			

#### Marchi di qualità

##### Quality marks

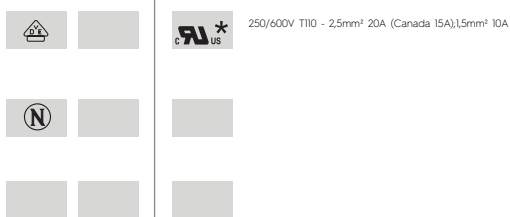

#### Direttive Europee

##### European directives

Conforme "RoHS"  
"RoHS" compliant

#### Pesi e confezioni

##### Weights and packaging

Art. Codice prodotti Product references	g Peso netto Net weight	n° pz per sacco per bag	n° pz per scatola per box	n° pz per cartone per carton
EPC1116	18,1	100		

#### Note

##### Notes

## ISTRUZIONI DEL COSTRUTTORE MANUFACTURER'S INSTRUCTIONS

1. I connettori sono intesi per connessione e disconnessione esclusivamente in assenza di tensione  
2. I test previsti nella norma EN61535+A1 sono stati eseguiti sui cavi 3/4/5G 1,5/2,5 H05VV-F ma i connettori EPC possono essere utilizzati con altri tipi di cavo a richiesta come Halogen free=H05ZIZI-F, Gomma=H07RN-F, Silicone=H05SS-F (in Spagna=RZI-K);  
3. I connettori non sono adatti per l'installazione in aree facilmente accessibili  
4. ELETPLAST informa che i prodotti EPC, quando questo è verificato e certificato da primari istituti di qualità (es. NEMKO, VDE), sono compatibili con prodotti similari di altri produttori. ELETPLAST è disponibile a informare sui marchi e i modelli per cui è stata certificata la compatibilità.

5. I connettori ELETPLAST non sono da intendersi come sostituzione delle spine e prese domestiche nazionali o prolunghe con adattatori multipli.  
6. I connettori della serie EPCOM sono conformi alla norma EN61535+A1 solo se provvisti di dispositivo d'aggancio.

Prima di iniziare qualsiasi opera, l'installatore deve assicurarsi che l'interruttore generale sia posizionato su "OFF" per prevenire ogni possibile rischio elettrico.  
Questi prodotti devono essere installati da un elettricista qualificato e cablati in conformità alle norme sul cablaggio IEE.

1. Installation couplers are intended for connection and disconnection without load, only;  
2. EN61535+A1 Test has been made on the 3/4/5G 1,5/2,5 H05VV-F but EPC connectors can be used also with other cables types are upon request as Halogen free=H05ZIZI-F, Rubber=H07RN-F, Silicon=H05SS-F (cable for Spain=RZI-K);  
3. This installation coupler is not suitable for installation in readily accessible areas;  
4. ELETPLAST informs the installer that EPC Products when verified and certified by a quality brand testing company as (NEMKO or VDE) accept the compatibility with similar products made by other manufacturer. ELETPLAST verified the attendibility test will inform the customer what are the brands and items approved. Any other connection with similar products made by other brands companies are not accepted nor warranted by EP;  
5. ELETPLAST's installation coupler systems are not replacements for the national domestic plug and socket outlet-system;  
6. EPCOM connectors are compliant with EN61535+A1 only when used with locking device.

Before commencing any electrical work, ensure the mains isolator on the consumer unit / fuse board is in the 'OFF' position, to prevent the possibility of electric shock.  
These products should be installed by a qualified electrician, and wired in accordance with the IEE Wiring Regulations.

Marchio/Mark	1,5 mm <sup>2</sup> solid	2,5 mm <sup>2</sup> solid
	10 A	20A
	10 A	20 A* *For Canada 15 A

### VITI

Coppia di serraggio delle viti:

### SCREWS

Screws torque:

	EPN2 EPS2	EPC3, 4, 5	EPN3, 4, 5	EPS3, 4, 5
M3 per conduttori/M3 conductors	0,5 Nm	0,5 Nm	0,5 Nm	0,5 Nm
M3 per copertura/M3 cover	0,3 Nm	0,6 Nm	0,6 Nm	0,6 Nm

## LUNGHEZZA SGUAINATURA CAVO ED OPZIONI PER COPERTURA BLOCCACAVO

### EPC3,4,5 con bloccacavo:

3P: 27mm (33mm PE) - ø7-8.3mm (versione standard),  
ø9-10.5mm (versione M, disponibile a richiesta);  
4P: 29mm (36mm PE) - ø8.4-10.5mm (standard version),  
ø10.0-12.0mm (versione M, disponibile a richiesta);  
5P: 31mm (39mm PE) - ø9.5-11.6mm (standard version),  
ø13.0-14.0mm (versione M, disponibile a richiesta)

### EPN3,4,5

3P: 27mm (35mm PE) - ø7.5-10.5mm (ø6-9.5mm con EPNR8)  
4P: 32mm (40mm PE) - ø7.0-12.5mm  
5P: 37mm (45mm PE) - ø9.5-14mm

**EPN2, EPS2 Mini:** 21mm - ø5.5-8mm

**EPN3, EPS3 Mini:** 20mm (24mm PE) - ø6-9mm

**EPN5, EPS5 Mini:** 30mm (38mm PE) - ø6-11mm

## DISMANTLING LENGTH, STRAIN RELIEF COVERS OPTIONS

### EPC3,4,5 with strain relief:

3P: 27mm (33mm PE) - ø7-8.3mm (standard version),  
ø9-10.5mm (M version, available on demand);  
4P: 29mm (36mm PE) - ø8.4-10.5mm (standard version),  
ø10.0-12.0mm (M version, available on demand);  
5P: 31mm (39mm PE) - ø9.5-11.6mm (standard version),  
ø13.0-14.0mm (M version, available on demand)

### EPN3,4,5:

3P: 27mm (35mm PE) - ø7.5-10.5mm (ø6-9.5mm with EPNR8)  
4P: 32mm (40mm PE) - ø7.0-12.5mm  
5P: 37mm (45mm PE) - ø9.5-14mm

**EPN2, EPS2 Mini:** 21mm - ø5.5-8mm

**EPN5, EPS5 Mini:** 20mm (24mm PE) - ø6-9mm

**EPN5, EPS5 Mini:** 30mm (38mm PE) - ø6-11mm