

9209/BD-L-B

9209/BD-L-W

BOX DRIVER PER ADATTATORE ASIMMETRICO
LED DRIVER BOX FOR ASYMMETRIC ADAPTER

Dati tecnici

Technical data

Caratteristiche









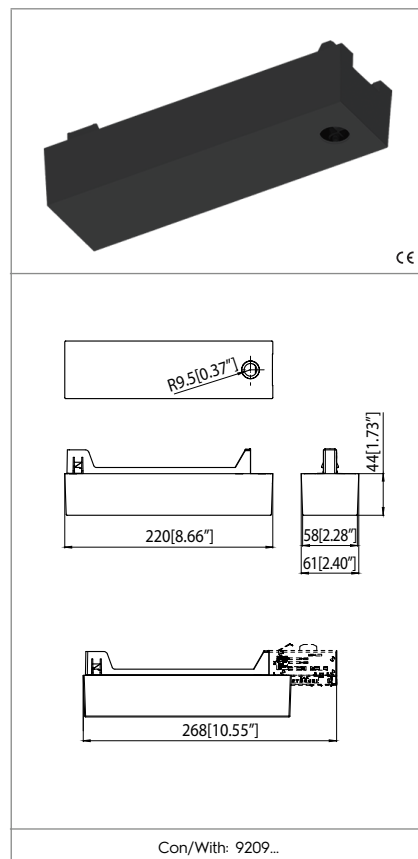



Characteristics

– Corpo in policarbonato. Colori disponibili: nero RAL9005 (B) e bianco RAL9010 (W)
– Polycarbonate body. Available colours: black RAL9005 (B) and white RAL9010 (W)

– Dimensione massima per alloggiamento driver: 162x52x30 mm
– Maximum housing space for driver: 162x52x30 mm

Adattatore asimmetrico non incluso
Asymmetric adapter is not included



	 S-9209-	 S-9209-BD-	 S-9209-
			
			

Marchi di qualità

Quality marks

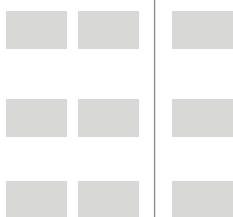

Direttive Europee

European directives

Conforme "RoHS"
"RoHS" compliant

Pesi e confezioni

Weights and packaging

Art. Codice prodotti Product references	g Peso netto Net weight	n° pz per sacco per bag	n° pz per scatola per box	n° pz per cartone per carton
9209/BD-L-B	164,4			
9209/BD-L-W	164,4			

Note

Notes

ACHTUNG

Alle durchzuführenden Installationen sind nur durch Fachpersonal auszuführen. Schalten Sie die Anlage vor der Montage aus. Beachten Sie bitte die nationalen Installationsvorschriften. Die A.A.G. Stucchi erlaubt die Verwendung des ONETRACK®-Systems nur in Verbindung mit A.A.G. Stucchi Teilen. Alle Teile müssen entsprechend den Installationsanweisungen verbaut werden. Die Herstellerfirma ist nicht verantwortlich für Sicherheit und Funktionalität des Systems bei Verwendung von Fremdteilen oder bei Abweichung von Installationsanweisungen. In solchen Fällen hat Anwender die elektrische, mechanische und thermische Verträglichkeit des Produkts und der damit verwendeten Komponenten zu gewährleisten. Installiert ist oder bei dem zu verwendenden Befestigungsmaterial. Die Schiene und die dazugehörigen Komponenten wie auch Anschlussadapter können nicht zusammen mit Zubehör ohne Qualitätsgütezeichen verwendet werden. In der A.A.G. Stucchi Stromschiene können nur entsprechende Verbinder von A.A.G. Stucchi eingesetzt werden. A.A.G. Stucchi Verbinder können nur mit Stromschienen von A.A.G. Stucchi verwendet werden. Das Gleis ist über die A.A.G. Stucchi Artikel 9001 / .. und 9002 /... .

Es ist strengstens untersagt, Lösungsmittel, Kleber, Öl, Fett oder Reinigungsmittel in Kontakt mit ONETRACK®-Komponenten zu verwenden. Das Unternehmen ist für keine verantwortlich Beschädigung durch die Verwendung der oben genannten Materialien.

Ein mechanischer Schlüssel im Profil der Schiene gewährleistet den richtigen Anschluß der jeweiligen Verbinder.

Ebenso haben Endverbinder und Stromverbinder einen meachnischen Schlüssel (wie im Bild dargestellt), der bei der Auswahl der richtigen Komponente in Betracht gezogen werden muss.

Im Katalog ist die Position des Schlüssel bei den entsprechenden Arikeln rot-gekennzeichnet.

WARNING

All the described operations of this instructions page must be performed by qualified personnel only. Disconnect power during installation or servicing. Please respect national and local installation regulations. A.A.G. Stucchi allows the use of A.A.G. Stucchi parts only in applications where the ONETRACK® system is used. These parts must be installed according to the installation instructions. The company as a manufacturer is not responsible for the safety and functionality of the system if parts not belonging to it are used or if there are any deviations from the installation instructions. It is then the user's responsibility to ensure the electrical, mechanical and thermal compatibility between the system and the fixtures used with it. The track, its components and also the adapters can't be used with accessories without the appropriate approvals. On A.A.G. Stucchi track one can use only A.A.G. Stucchi connections. A.A.G. Stucchi connections can be used only with A.A.G. Stucchi tracks. The track is to be connected to electrical power by means of the A.A.G. Stucchi articles 9001/.. and 9002/...

It is strictly forbidden to use any kind of solvent, glue, oil, grease or cleaner in contact with ONETRACK® components. The company is not responsible of any damage caused by the use of the materials mentioned above.

There a mechanical key on the track to guarantee the proper connection of multiple pieces of track. This key is present on all end-feeds and connecting components (see screw below-pictured). Care must be taken when ordering to select the correct components. The catalog drawing depict the position of the key with a red line.

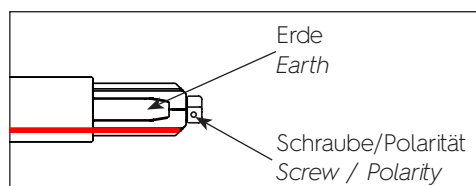

ISTRUZIONI DI MONTAGGIO BOX DRIVER

MOUNTING INSTRUCTIONS BOX DRIVER

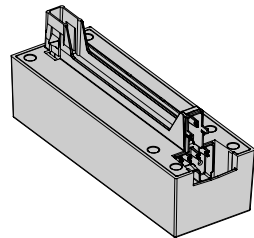

9209/BD-M...

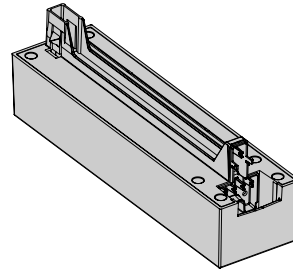

9209/BD-L...

