

## 3801/V-M-3P-BK

### SPINA DI CONNESSIONE PROTETTA PROTECTED CONNECTION PLUG

#### Dati tecnici

##### Technical data

- Poli - Poles	2P+E
- Corrente e tensione nominale - Rated current and voltage	16A-400V
- Temperatura massima di funzionamento (IEC) - Maximum operating temperature (IEC)	T100
- Grado di protezione - Protection index	IP66/68
- Grado di inquinamento - Pollution degree	2

#### Caratteristiche









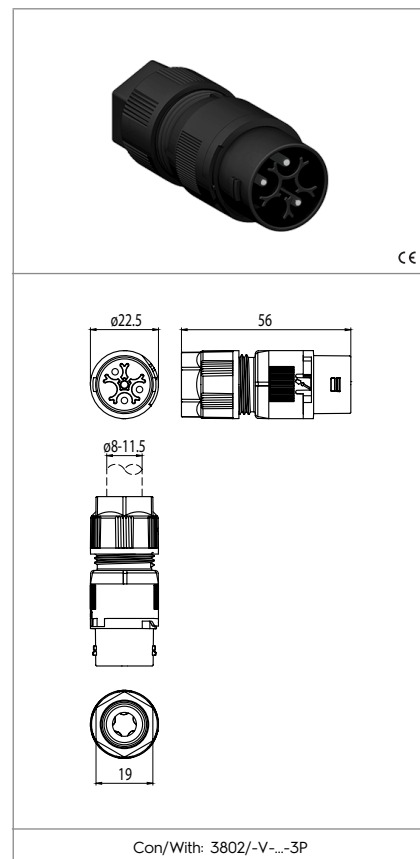



##### Characteristics

- Corpo in poliammide nera  
– Black polyamide body
- Contatti in ottone argentato  
– Silver plated brass contacts

marchiature: L,N,T

Marking: L,N,E



 senza fissaggio without fixing	 serrafilo con vite e morsetto screw terminals	 diametro conduttore flessibile con fascetta diameter of the flexible conductor with ferrule max.1,4	 sezione conduttore flessibile section of the flexible conductor mm <sup>2</sup> 0,5-1,5
 sezione conduttori rigidi rigid conductor section mm <sup>2</sup> 0,5-1,5	 spelatura cavetti rigidi e flessibili (con o senza fascetta) rigid and flexible wires stripping (with or without ferrule) 6	 adatto per tensione di accensione ad impulsi fino a... suitable for impulse ignition voltage up to... EN61535 4kV	 protetto IP66/68 (3m/2h) IP66 IP68 IP66/68 protected (3m/2h)
 S-3800/117	 S-3800/118		

#### Marchi di qualità

##### Quality marks

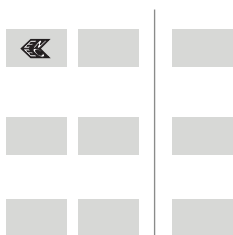

#### Direttive Europee

##### European directives

Conforme "RoHS"  
"RoHS" compliant

#### Pesi e confezioni

##### Weights and packaging

Art. Codice prodotti Product references	g Peso netto Net weight	n° pz per sacco per bag	n° pz per scatola per box	n° pz per cartone per carton
3801/V-M-3P-BK				

#### Note

##### Notes

## AVVERTENZE E ISTRUZIONI DI MONTAGGIO CONNETTORI PROTETTI IP66/68 SERIE 3800

I connettori da installazione sono destinati solo alla connessione e sconnessione senza carico.

Il cavo di alimentazione deve sempre essere collegato al connettore presa 3802/M...

La conformità alla IEC61535 non previene la compatibilità pericolosa del connettore da installazione con quelli di altri produttori.

Si devono utilizzare cavetti di sezione adeguata alla corrente per l'eventuale collegamento passante e si possono utilizzare cavetti di sezione inferiore per derivare l'alimentazione dell'apparecchio di illuminazione.

I connettori da installazione non sostituiscono i sistemi presa-spina nazionali per uso domestico.

La serie di connettori 3800 non è adatta all'installazione in zone facilmente accessibili.

### CAVI UTILIZZABILI:

Con guarnizione 3800/117 (ø6,5mm):

- FROR: 2X0,75mm<sup>2</sup>; 3X0,5mm<sup>2</sup>; 3X0,75mm<sup>2</sup>; 5X0,5mm<sup>2</sup>; 5X0,75mm<sup>2</sup>
- H05RN-F: 2X0,75mm<sup>2</sup>; 3X0,75mm<sup>2</sup>; 3X1mm<sup>2</sup>;
- H05SS-F/G: 2x1mm<sup>2</sup>; 3x0,75mm<sup>2</sup>
- H05VV-F: 2x0,75mm<sup>2</sup>; 2x1mm<sup>2</sup>; 3x0,75mm<sup>2</sup>; 3x1mm<sup>2</sup>
- FLEX OIL PLUS: 5x1mm<sup>2</sup>

Con guarnizione 3800/118 (ø8mm):

- FROR: 2X1mm<sup>2</sup>; 2X1,5mm<sup>2</sup>; 3X1mm<sup>2</sup>; 3X1,5mm<sup>2</sup>; 4X1mm<sup>2</sup>;
- H07RN-F: 2X1mm<sup>2</sup>
- H05VV-F: 2X1,5mm<sup>2</sup>; 3X1,5mm<sup>2</sup>
- G/Silicone: 3X1,5mm<sup>2</sup>
- H05ZIZI-F Halogen free: 3X1mm<sup>2</sup>
- H05RN-F: 4X0,75mm<sup>2</sup>
- H05SS-F/G: 4X1mm<sup>2</sup>; 5X1mm<sup>2</sup>

Con guarnizione 3800/119 (ø11,5mm):

- FG7OR: 2X1,5mm<sup>2</sup>; 3X1,5mm<sup>2</sup>
- FROR: 4X1,5mm<sup>2</sup>; 5X1mm<sup>2</sup>; 5X1,5mm<sup>2</sup>;
- H07RN-F: 4X1mm<sup>2</sup>; 4X1,5mm<sup>2</sup>; 5X1,5mm<sup>2</sup>
- H05VV-F: 4X1,5mm<sup>2</sup>; 5X1,5mm<sup>2</sup>
- OFLEX HEAT 145MC: 4X1,5mm<sup>2</sup>
- FG70H2R: 5X1,5mm<sup>2</sup>
- FLEX OIL (FROR): 5X1,5mm<sup>2</sup>
- OFLEX HEAT: 5X1,5mm<sup>2</sup>
- FG7OMI: 5X1,5mm<sup>2</sup>

## WARNINGS AND MOUNTING INSTRUCTIONS FOR IP66/68 SERIES 3800 CONNECTORS

Installation couplers are intended for connection and disconnection without load, only.

The supply cable must be always connected to the connection socket. 3802/M...

Compliance with IEC61535 does not prevent dangerous compatibility between different manufacturer installation coupler system.

Wires with a suitable section for the current involved must be used for the eventual passing through connection and wires with reduced section can be used to supply the internal circuit of the lighting fitting.

Installation coupler system are not replacement for the national domestic plug and socket system.

3800 series connectors are not suitable for installation in easily accessible areas.

### SUITABLE CABLES:

With 3800/117 gasket (ø6,5mm):

- FROR: 2X0,75mm<sup>2</sup>; 3X0,5mm<sup>2</sup>; 3X0,75mm<sup>2</sup>; 5X0,5mm<sup>2</sup>; 5X0,75mm<sup>2</sup>
- H05RN-F: 2X0,75mm<sup>2</sup>; 3X0,75mm<sup>2</sup>; 3X1mm<sup>2</sup>;
- H05SS-F/G: 2x1mm<sup>2</sup>; 3x0,75mm<sup>2</sup>
- H05VV-F: 2x0,75mm<sup>2</sup>; 2x1mm<sup>2</sup>; 3x0,75mm<sup>2</sup>; 3x1mm<sup>2</sup>
- FLEX OIL PLUS: 5x1mm<sup>2</sup>

With 3800/118 gasket (ø8mm):

- FROR: 2X1mm<sup>2</sup>; 2X1,5mm<sup>2</sup>; 3X1mm<sup>2</sup>; 3X1,5mm<sup>2</sup>; 4X1mm<sup>2</sup>;
- H07RN-F: 2X1mm<sup>2</sup>
- H05VV-F: 2X1,5mm<sup>2</sup>; 3X1,5mm<sup>2</sup>
- G/Silicone: 3X1,5mm<sup>2</sup>
- H05ZIZI-F Halogen free: 3X1mm<sup>2</sup>
- H05RN-F: 4X0,75mm<sup>2</sup>
- H05SS-F/G: 4X1mm<sup>2</sup>; 5X1mm<sup>2</sup>

With 3800/119 gasket (ø11,5mm):

- FG7OR: 2X1,5mm<sup>2</sup>; 3X1,5mm<sup>2</sup>
- FROR: 4X1,5mm<sup>2</sup>; 5X1mm<sup>2</sup>; 5X1,5mm<sup>2</sup>;
- H07RN-F: 4X1mm<sup>2</sup>; 4X1,5mm<sup>2</sup>; 5X1,5mm<sup>2</sup>
- H05VV-F: 4X1,5mm<sup>2</sup>; 5X1,5mm<sup>2</sup>
- OFLEX HEAT 145MC: 4X1,5mm<sup>2</sup>
- FG70H2R: 5X1,5mm<sup>2</sup>
- FLEX OIL (FROR): 5X1,5mm<sup>2</sup>
- OFLEX HEAT: 5X1,5mm<sup>2</sup>
- FG7OMI: 5X1,5mm<sup>2</sup>

## ISTRUZIONI DI MONTAGGIO PER CONNETTORI CON SERRAFILO A VITE

Lunghezze di sguainatura del cavo e spelatura dei conduttori; scelta della guarnizione.

## MOUNTING INSTRUCTION FOR CONNECTORS WITH SCREW TERMINALS

Cable and conductors strip lengths; gasket choices.

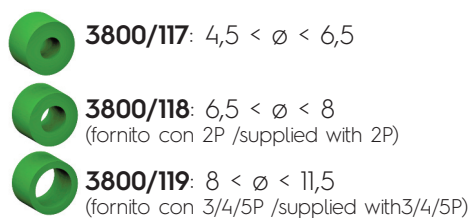
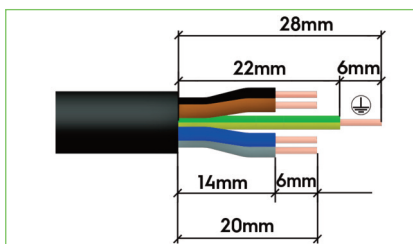

### Connessione dei conduttori

Inserire il cavo (1) attraverso il dado bloccacavo (2), la guarnizione (3) e il corpo (4).

### Wires connection

Insert the cable (1) through the clamp nut (2), the gasket (3) and the body (4).

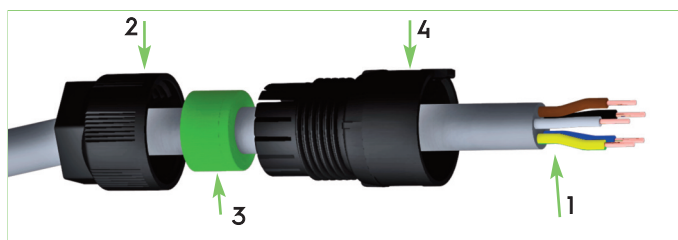

Collegare i conduttori ai serrafilo a vite del frutto (5). Inserire il frutto nel corpo in modo da posizionare la linguetta (6) nell'apposita cava (7) (fig.B). Ruotare il corpo fino a raggiungere la posizione corretta (fig. E).

Connect the conductors into the screw terminals (5). Insert the module into the body so that the tab (6) is placed inside the cavity (7) (pic.B). Rotate the body to reach the correct position (pic. E).

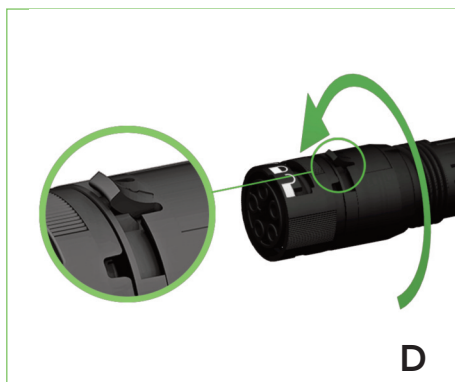
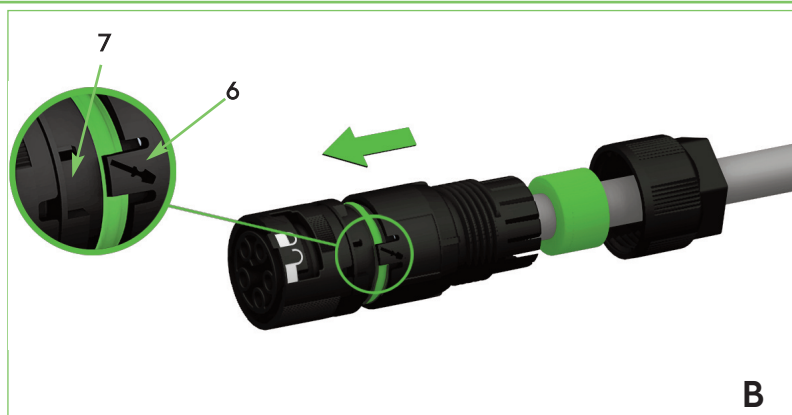
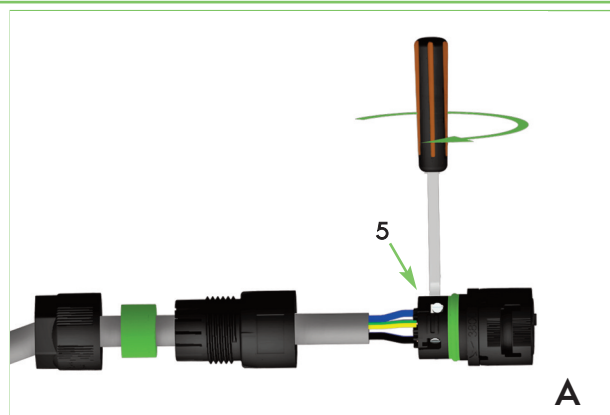

Inserire la guarnizione (8) nel corpo del connettore (9).

Place the gasket (8) into the connector body(9).

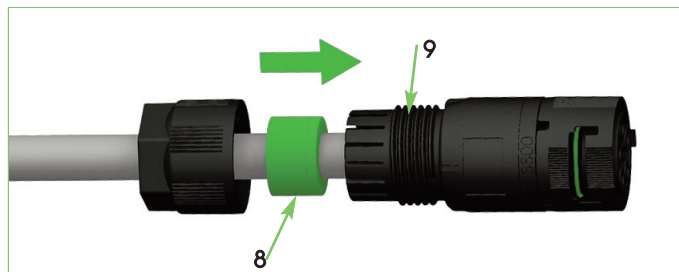

Avvitare il dado (10) al corpo (9) in modo da bloccare il cavo e stringere la guarnizione. Il dado (10) va serrato con una chiave (coppia di serraggio 2,5 Nm) tenendo ben fermo il corpo.

Tighten the nut (10) on the body (9) to lock the cable and tighten the gasket. The nut (10) must be tightened with a wrench applying a force of 2,5 Nm while keeping the body of the connector in place.

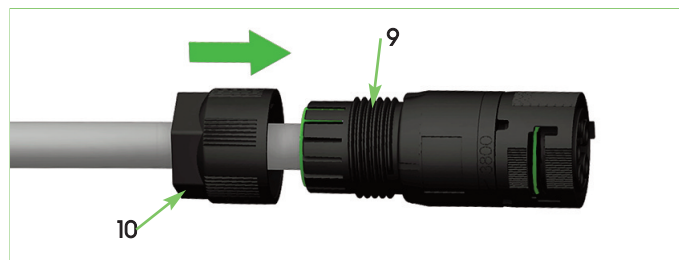

#### ATTENZIONE

Per assicurare il grado di protezione non deve essere applicata alla connessione nessuna forza torcente (es. non attaccare pesi al cavo, etc.).

**N.B.:** il raggio di curvatura del cavo di alimentazione deve essere almeno 4 volte il valore del diametro del cavo.

#### CAUTION

To ensure protection category do not expose the connection to any bending force (e.g. do not attach weight to the cable, etc.).

**N.B.:** The minimum bending radius for conductors has to be more than 4 times the conductor diameter.

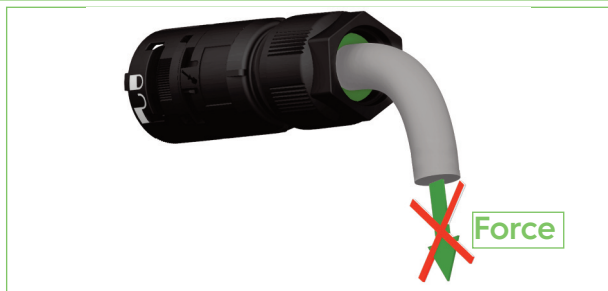

In caso fosse necessario smontare il prodotto, sollevare la linguetta  con un utensile e ruotare il corpo come da figura.

In case you need to dismantle the product, lift the tab  with a tool and rotate the product as per picture.



### ISTRUZIONI PER IL CORRETTO ACCOPPIAMENTO DEI CONNETTORI

Accoppiare i due connettori inserendo la spina nella presa.

### INSTRUCTIONS FOR CONNECTOR COUPLING

Couple connectors inserting the plug into the socket.

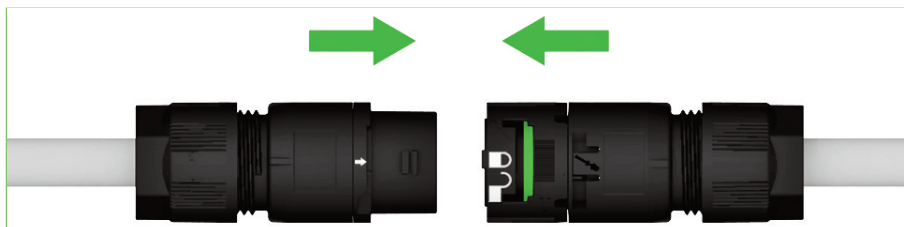

Una volta accoppiati correttamente i connettori si trovano in posizione di sicurezza .

Once coupled completely the indicator will show the secure position .



### ISTRUZIONI PER IL DISACCOPIAMENTO

Ruotare la ghiera fino alla posizione di sblocco .

### INSTRUCTIONS FOR UNCOUPLING THE CONNECTORS

Rotate the tool so that collar reaches the unlocking position .



Estrarre il connettore tirandolo per il corpo (non tirare il cavo).

Disconnect by pulling the body of the connector and not the cable.

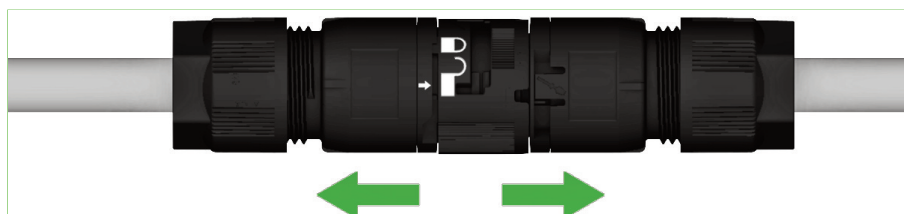

## CONNETTORI PER FISSAGGIO A PARETE CON SERRAFILO A VITE

### Istruzioni di montaggio dei connettori a parete

Inserire il cavo/i cavetti di connessione nel dado di fissaggio (1) poi nel foro dell'apparecchio (2) ed infine nel corpo (3) su cui è montata la guarnizione (4).

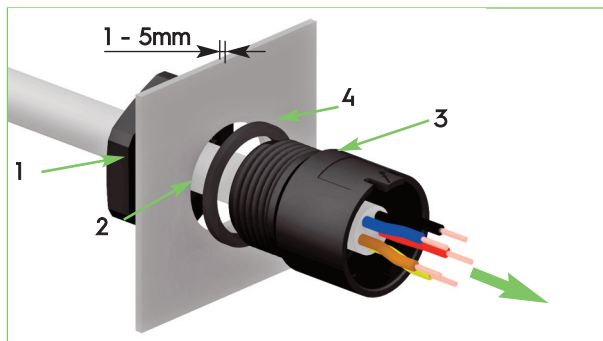

Collegare i conduttori ai serrafilo a vite del frutto (5). Inserire il frutto nel corpo in modo da posizionare la linguetta (6) nell'apposita cava (7) (fig. B). Ruotare il corpo fino a raggiungere la posizione in fig. E.

## CONNECTORS FOR PANEL MOUNTING WITH SCREW TERMINALS

### Mounting instructions for panel mounting connectors

Insert the cable/the connectors through the fixing nut (1), then into the hole (2) and after into the body (3) with the gasket (4) already mounted.

Connect the conductors into the screw terminals (5). Insert the module into the body so that the tab (6) is placed inside the cavity (7) (pic. B). Rotate the body to reach the correct position (pic. E).

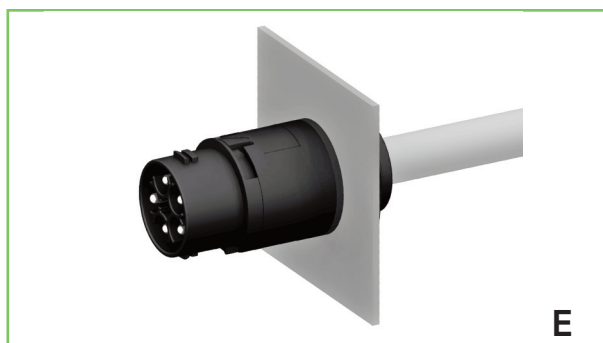
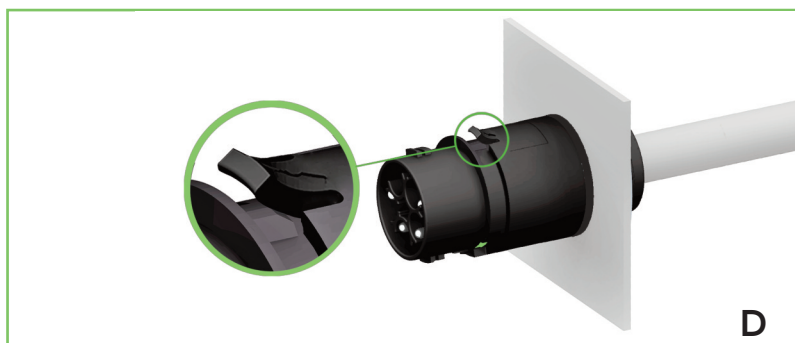
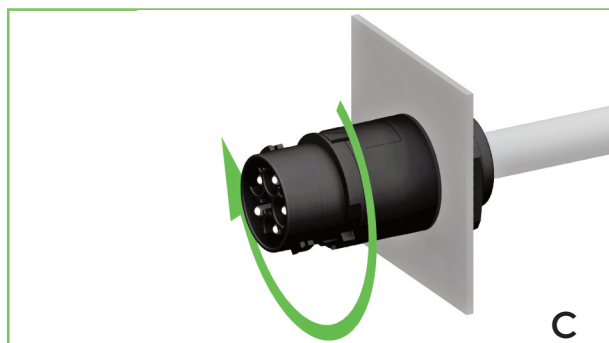
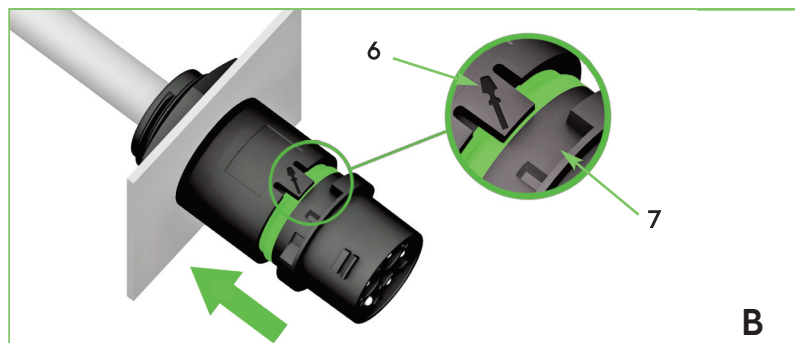
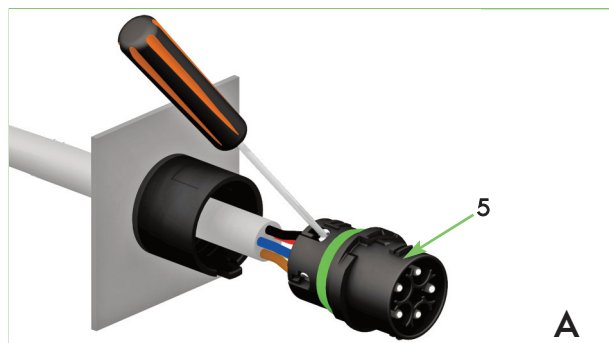

## ISTRUZIONI PER IL CORRETTO ACCOPPIAMENTO DEI CONNETTORI

Accoppiare i due connettori inserendo la spina nella presa.

## INSTRUCTIONS FOR CONNECTOR COUPLING

Couple connectors inserting the plug into the socket.

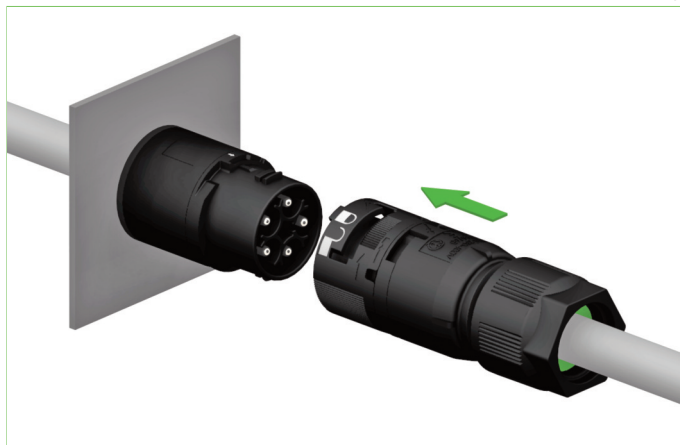

Una volta accoppiati correttamente i connettori si trovano in posizione di sicurezza .

Once coupled completely the indicator will show the secure position .

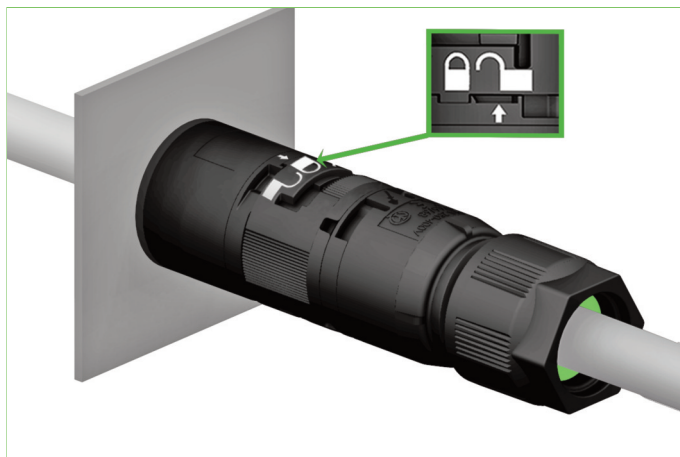

#### ISTRUZIONI PER IL DISACCOPIAMENTO

Ruotare l'utensile in modo da far scorrere la ghiera fino alla posizione di sblocco  .

#### INSTRUCTIONS FOR CONNECTORS UNCOUPLING

Rotate the tool so that collar reaches the unlocking position  .

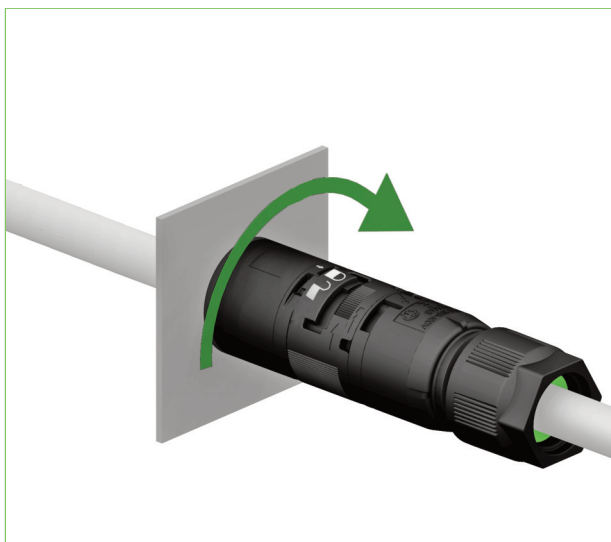

Estrarre il connettore tirandolo per il corpo (non tirare il cavo).

Disconnect by pulling the body of the connector and not the cable.

