

**683/A**

**683/AR**

**MORSETTI CON PORTAFUSIBILE PER APPARECCHI DI ILLUMINAZIONE**  
**TERMINAL BLOCKS WITH FUSEHOLDER FOR LIGHTING FIXTURES**

**Dati tecnici**

*Technical data*

- Poli - Poles	2P+E
- Corrente e tensione nominale - Rated current and voltage	2,5W/6,3A-250V 6A-400V
- Temperatura massima di funzionamento (IEC) - Maximum operating temperature (IEC)	T70
- Grado di protezione - Protection index	IP20

**Caratteristiche**

*Characteristics*

...R= morsetto di terra a bussola con viti

...R= with screwed earth facility

– Corpo in policarbonato bianco  
– White polycarbonate body

– Corpo serrafile in ottone  
– Internal part in brass

– Connessione di terra in acciaio nichelato  
– Earth connection in nickel plated steel

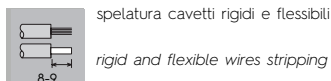
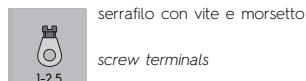
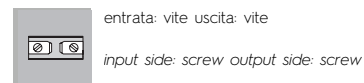
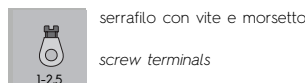
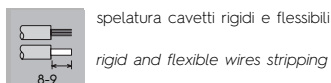
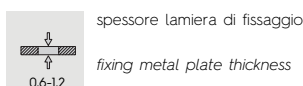
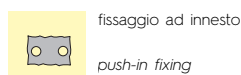
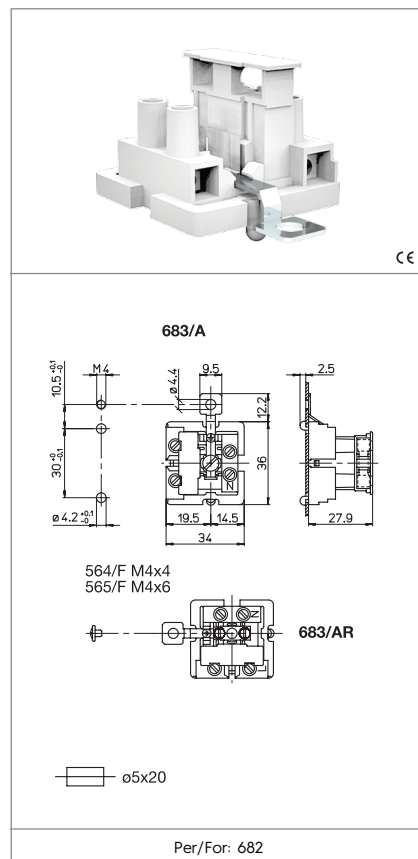

**Marchi di qualità**  
*Quality marks*

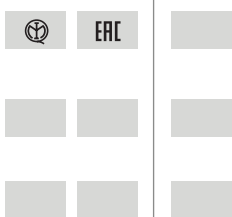

**Direttive Europee**  
*European directives*

Conforme "RoHS"  
"RoHS" compliant  
Non soggetto alla "RAEE"  
Not subject to "WEEE"

**Pesi e confezioni**  
*Weights and packaging*

Art. Codice prodotti Product references	g Peso netto Net weight	n° pz per sacco per bag	n° pz per scatola per box	n° pz per cartone per carton
683/A	14,4	500	200	
683/AR	18,2		200	

**Note**

Notes