

686/V

686/VR

MORSETTI CON PORTAFUSIBILE PER APPARECCHI DI ILLUMINAZIONE
TERMINAL BLOCKS WITH FUSEHOLDER FOR LIGHTING FIXTURES

Dati tecnici

Technical data

- Poli - Poles	2P+E
- Corrente e tensione nominale - Rated current and voltage	2,5W/6,3A-250V 6A-400V
- Temperatura massima di funzionamento (IEC) - Maximum operating temperature (IEC)	T70
- Grado di protezione - Protection index	IP20

Caratteristiche

Characteristics

...R= morsetto di terra a bussola con viti









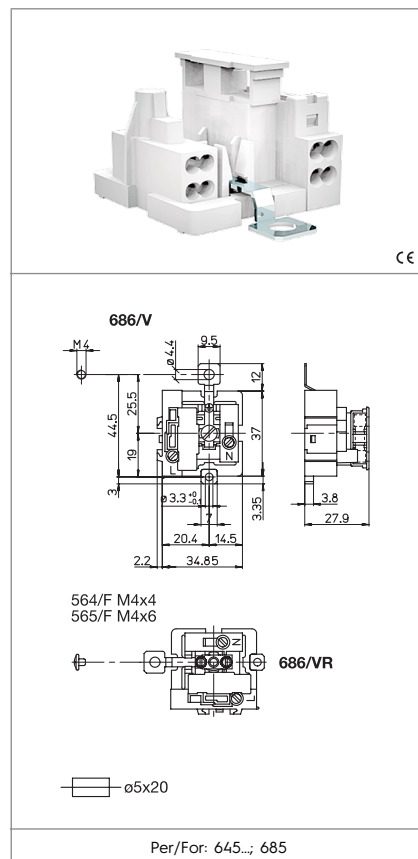



...R= with screwed earth facility

– Corpo in policarbonato bianco
– White polycarbonate body

– Corpo serrafilo in ottone stagnato
– Internal part in tin plated brass

– Connessione di terra in acciaio nichelato
– Earth connection in nickel plated steel



 fissaggio con vite screw fixing			
			
			

Marchi di qualità

Quality marks

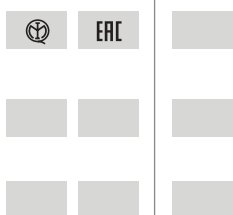

Direttive Europee

European directives

Conforme "RoHS"
"RoHS" compliant
Non soggetto alla "RAEE"
Not subject to "WEEE"

Pesi e confezioni

Weights and packaging

Art. Codice prodotti Product references	g Peso netto Net weight	n° pz per sacco per bag	n° pz per scatola per box	n° pz per cartone per carton
686/V	16,7	500		
686/VR	20,5	500		

Note

Notes