

9000-UL8/B-ST-120

9000-UL8/W-ST-120

BINARIO A 6 CONDUTTORI EUROSTANDARD PLUS®
EUROSTANDARD PLUS® 6 CONNECTORS TRACK

Dati tecnici

Technical data

- Frequenza - Frequency	60Hz
- Corrente e tensione nominale - Rated current and voltage	120V-20A 1A-50Vac FELV
- Carico sul circuito - Circuit power	2,4kVA

Caratteristiche

Characteristics

L1/L2/L3/N/terra 3x120V/20A + D+/D- 2x1A/50V FELV AC (DALI)
L1/L2/L3/N/ground 3x120V/20A + D+/D- 2x1A/50V FELV AC (DALI)

- Lunghezza: 8 ft
- Length: 8 ft
- Estruso esterno in alluminio. Colori disponibili: nero (B) e bianco (W)
- External extruded body in aluminium. Available colours: black (B) and white (W)
- Estruso isolante in PVC
- Insulated extruded body in PVC
- Conduttori in rame
- Copper conductors

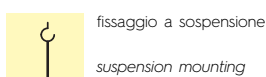
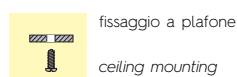
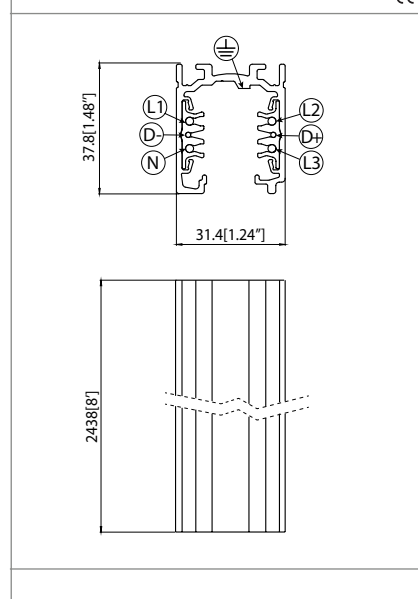
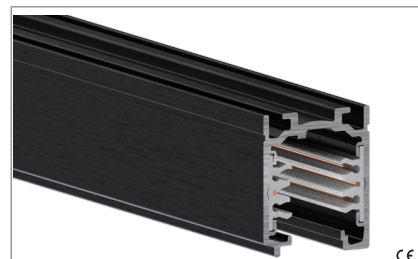

Marchi di qualità

Quality marks

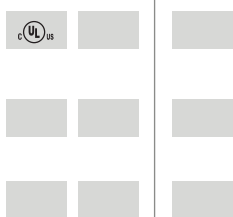

Direttive Europee

European directives

Conforme "RoHS"
"RoHS" compliant

Pesi e confezioni

Weights and packaging

Art. Codice prodotti Product references	g Peso netto Net weight	n° pz per sacco per bag	n° pz per scatola per box	n° pz per cartone per carton
9000-UL8/B-ST-120				
9000-UL8/W-ST-120				

Note

Notes

ATTENZIONE

Tutte le operazioni descritte in questo foglio di istruzioni devono essere eseguite da personale specializzato, escludendo tensione dall'impianto e rispettando le norme nazionali di installazione. A.A.G. Stucchi permette solo l'utilizzo dei componenti A.A.G. Stucchi all'interno delle applicazioni che utilizzano il sistema ONETRACK®. Questi componenti devono essere installati secondo le istruzioni di montaggio fornite dall'azienda. L'azienda, come produttrice, non è responsabile della sicurezza e del funzionamento del sistema in caso si utilizzino componenti non appartenenti ad esso o se le istruzioni di montaggio non venissero rispettate. È inoltre responsabilità dell'utente garantire la compatibilità elettrica, meccanica e termica tra il sistema ONETRACK® e gli apparecchi di illuminazione utilizzati. Il binario ed i suoi componenti, compresi gli adattatori, non sono intercambiabili con accessori che non riportino il Marchio di Qualità. Sul binario A.A.G. Stucchi è possibile utilizzare solo le connessioni A.A.G. Stucchi. Le connessioni A.A.G. Stucchi possono essere utilizzate solo su binari A.A.G. Stucchi.

Il collegamento elettrico alla rete può essere effettuato soltanto tramite gli art. 9001/... e 9002/...

È severamente vietato utilizzare qualsiasi tipo di solvente, colla, olio, sgrassatore o detergente a contatto con tutti i componenti del sistema ONETRACK®. L'azienda non è responsabile di eventuali danni causati dall'utilizzo di suddetti materiali.

Il profilo del binario ha una chiave meccanica per rispettare il giusto collegamento tra gli spezzoni di binario.

Anche le testate ed i giunti di collegamento presentano una chiave meccanica (presenza vite - vedi figura sotto) che deve essere tenuta in considerazione per la scelta del giusto componente.

Nei disegni di catalogo di questi accessori il posizionamento della chiave meccanica è evidenziato da una linea rossa.

WARNING

All the described operations of this instructions page must be performed by qualified personnel only. Disconnect power during installation or servicing. Please respect national and local installation regulations. A.A.G. Stucchi allows the use of A.A.G. Stucchi parts only in applications where the ONETRACK® system is used. These parts must be installed according to the installation instructions. The company as a manufacturer is not responsible for the safety and functionality of the system if parts not belonging to it are used or if there are any deviations from the installation instructions. It is then the user's responsibility to ensure the electrical, mechanical and thermal compatibility between the system and the fixtures used with it. The track, its components and also the adapters can't be used with accessories without the appropriate approvals. On A.A.G. Stucchi track one can use only A.A.G. Stucchi connections. A.A.G. Stucchi connections can be used only with A.A.G. Stucchi tracks. The track is to be connected to electrical power by means of the A.A.G. Stucchi articles 9001/.. and 9002/...

It is strictly forbidden to use any kind of solvent, glue, oil, grease or cleaner in contact with ONETRACK® components. The company is not responsible of any damage caused by the use of the materials mentioned above.

There a mechanical key on the track to guarantee the proper connection of multiple pieces of track. This key is present on all end-feeds and connecting components (see screw below-pictured). Care must be taken when ordering to select the correct components. The catalog drawing depict the position of the key with a red line.

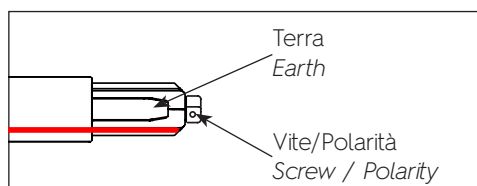

Binario standard / recessed
Standard / recessed track

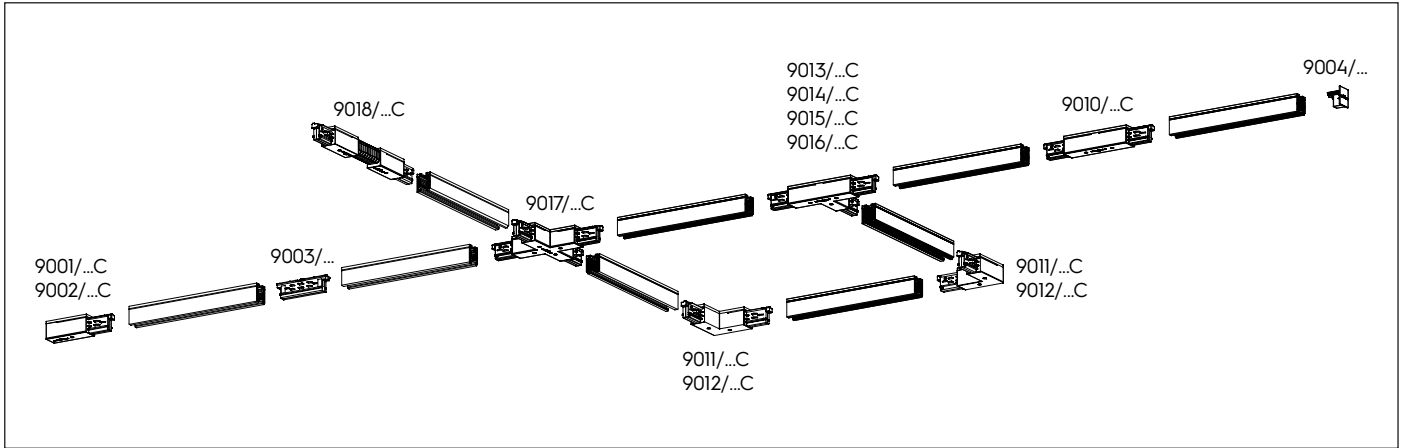

Binario H
H track

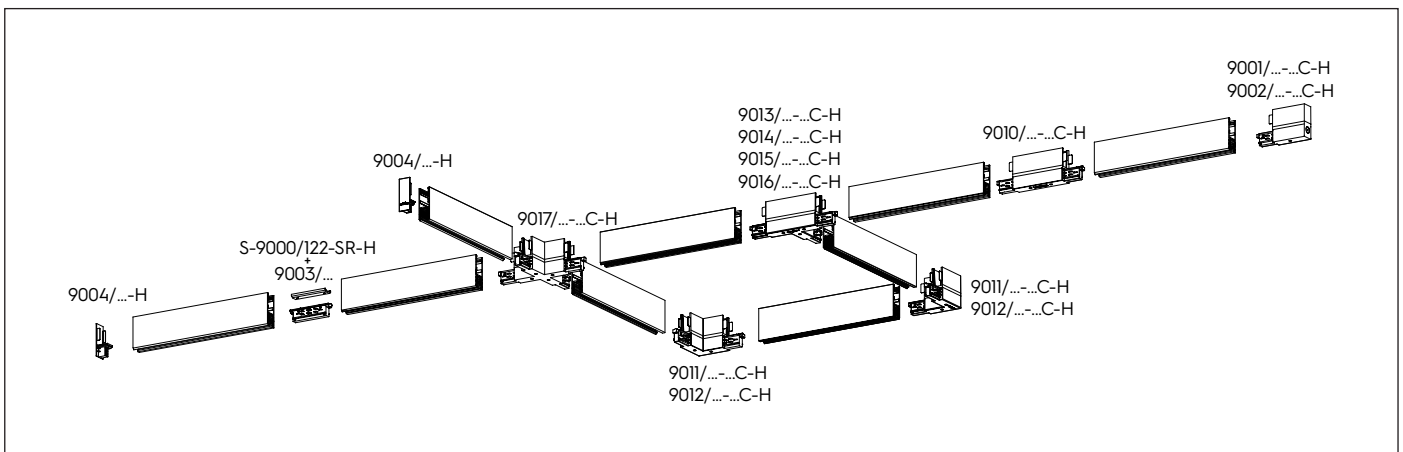

Binario trimless
Trimless track

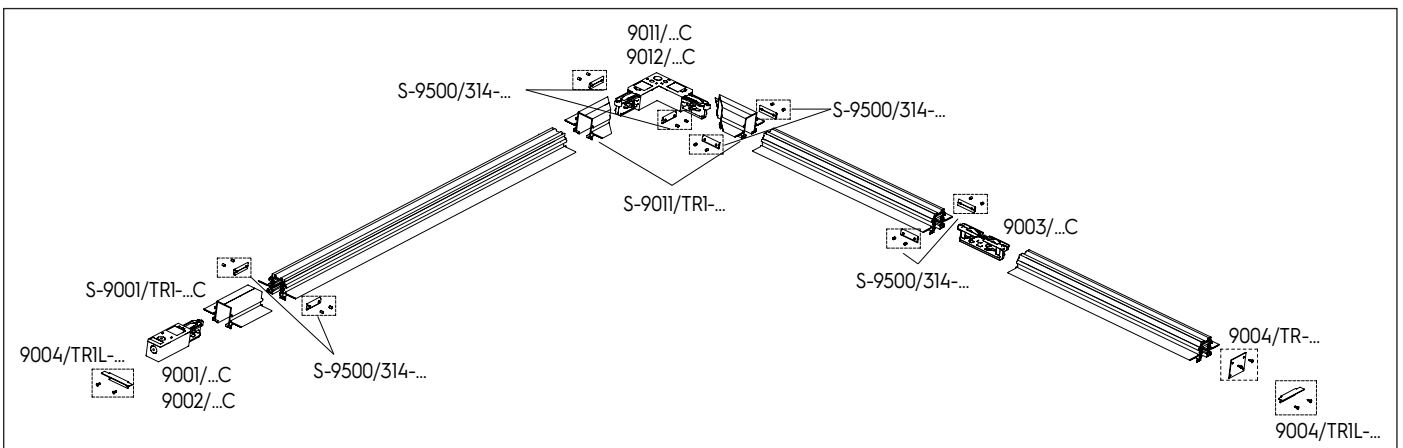

Il sistema binario OneTrack® è un sistema misto trifase con due conduttori aggiuntivi per la gestione di un qualsiasi segnale (per esempio dali, dmx, lon, eib, ecc). Il sistema è in fase di certificazione secondo la norma EN 60570 e la sua installazione deve essere eseguita da personale qualificato senza superare i carichi massimi (vedi fig). Durante il cablaggio elettrico bisogna rispettare lo schema elettrico indicato.

A.A.G. Stucchi OneTrack® system is a 3 phase mixed system with two additional conductors intended to manage a general data signal (for example dali, dmx, lon, eib, etc.). The system is in the proces to be EN 60570 certified and its installation must be accomplished by highly qualified person without exceeding the maximum loads (see pics). During the wiring the electrical the scheme must be followed.

**BINARIO TRIFASE + SEGNALE DI CONTROLLO:
9000-.../...-ST e 9000-.../...-R**

**THREE-PHASE TRACK + CONTROL SYSTEM:
9000-.../...-ST AND 9000-.../...-R**

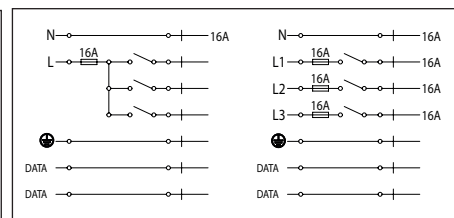
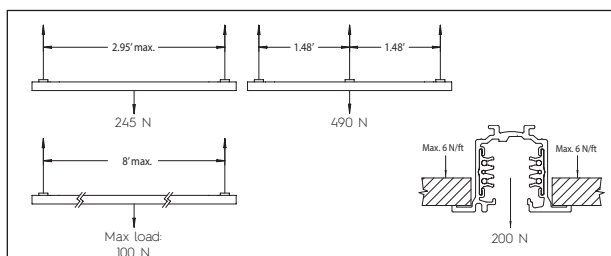
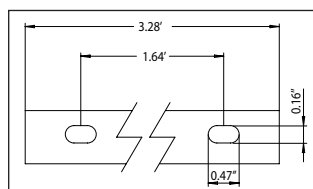
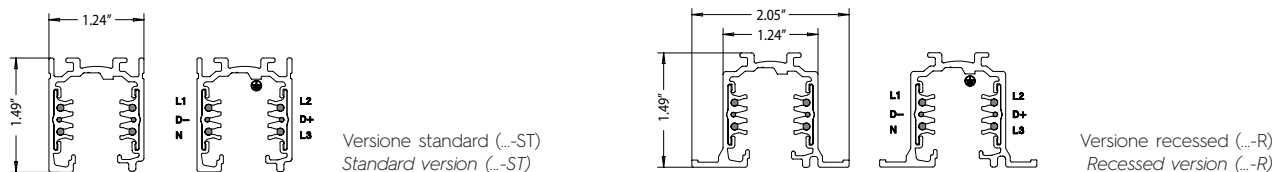

**BINARIO TRIFASE + SEGNALE DI CONTROLLO:
9000-.../...-H**

**THREE-PHASE TRACK + CONTROL SYSTEM:
9000-.../...-H**

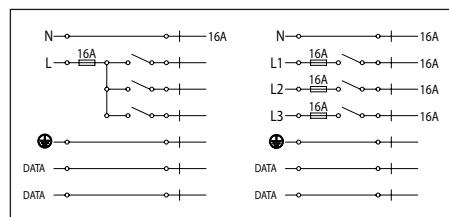
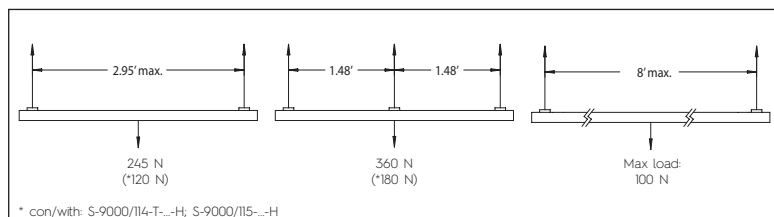
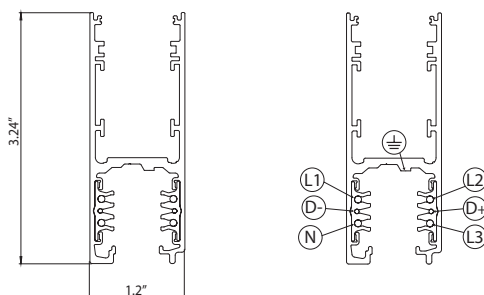

**BINARIO TRIFASE + SEGNALE DI CONTROLLO:
9000-.../...-TR**

**THREE-PHASE TRACK + CONTROL SYSTEM:
9000-.../...-TR**

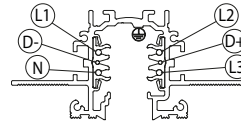
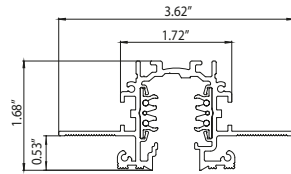

Versione trimless (...-TR)
Standard trimless (...-TR)

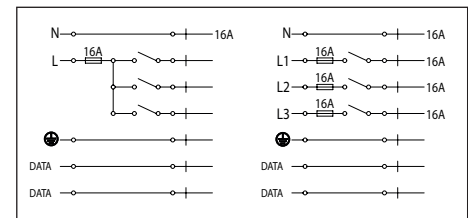
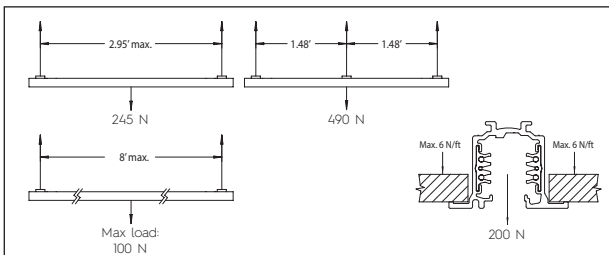

Schema di carico
Load scheme

Schema elettrico
Electrical scheme

**BINARIO TRIFASE + SEGNALE DI CONTROLLO:
9000-.../...-ST15**

**THREE-PHASE TRACK + CONTROL SYSTEM:
9000-.../...-ST15**

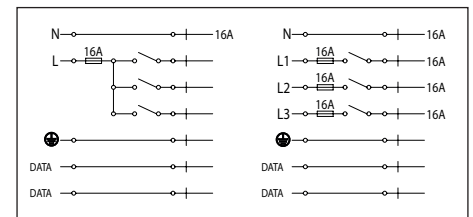
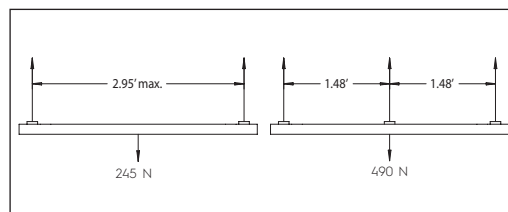
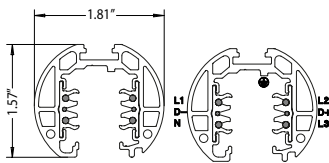

Versione round (...-ST15)
Round version (...-ST15)

Schema di carico
Load scheme

Schema elettrico
Electrical scheme

Le barre di binario di lunghezza 4-8-12 ft vengono fornite con i conduttori di rame già incassati come prescritto dalla norma di sicurezza. Nel caso in cui si abbia la necessità di accorciare la lunghezza del binario in fase di installazione, dopo il taglio utilizzare la pinza speciale (S-9000/T per ...ST, ...R, ...H - S-9000/T-TR per ...TR) avendo cura di intestare i 4 conduttori (L1-L2-L3-N) di almeno 0,20" per garantire le corrette distanze elettriche in aria e superficiali (fig. 4 e 5).

The track bars with length 4-8-12 ft are provided with the copper conductors already recessed, in compliance with the relevant safety standard. If it is necessary to shorten the track during installation, after the cut it is necessary to use the special cutting tool (S-9000/T with ...ST, ...R, ...H - S-9000/T-TR with ...TR) to recess the 4 conductors (L1-L2-L3-N) at least of 0,20" so that the correct air, surface and electrical distances are respected (pic. 4 and 5).

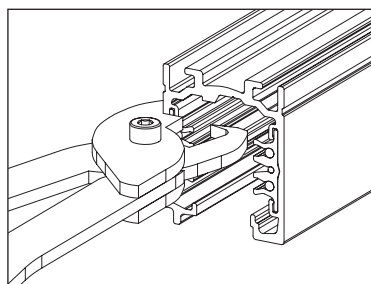

Fig. 4 Intestazione conduttori del binario
Pic. 4 Recessing track conductors

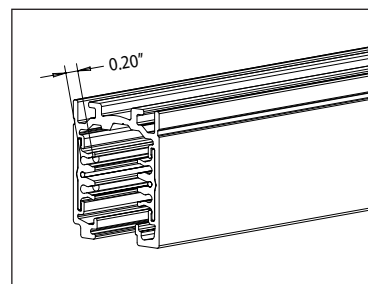

Fig. 5 Intestazione minima
Pic. 5 Minimum recessing