

652/A

MORSETTO CONNETTORE PRESA SOCKET TERMINAL BLOCK

Dati tecnici

Technical data









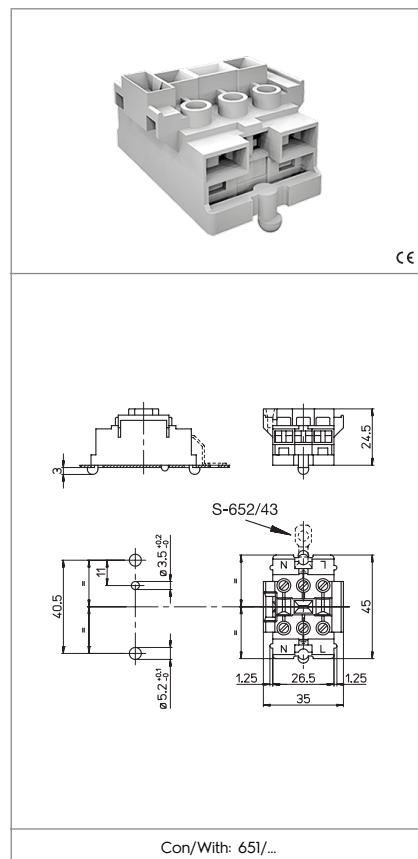



- Poli - Poles	2P+E
- Corrente e tensione nominale - Rated current and voltage	16A-400V
- Temperatura massima di funzionamento (IEC) - Maximum operating temperature (IEC)	T65
- Grado di protezione - Protection index	IP20
- Cat. sovratensione / Grado di inquinamento - Impulse withstand cat. / Pollution degree	III / 2

Caratteristiche

Characteristics

- Corpo in policarbonato bianco
- White polycarbonate body
- Corpo serrafilo in ottone nichelato
- Internal part in nickel plated brass



 fissaggio ad innesto push-in fixing	 spessore lamiera di fissaggio fixing metal plate thickness 0,6-1	 adatto per tensione di accensione ad impulsi fino a... suitable for impulse ignition voltage up to... 4kV	 S-652/43
 serrafilo con vite e dado terminals with screw and nut 1-2,5	 spelatura cavetti rigidi e flessibili rigid and flexible wires stripping 9-10	 serrafilo con vite e dado terminals with screw and nut 1-2,5	 entrata: vite uscita: vite input side: screw output side: screw
 serrafilo con vite e dado terminals with screw and nut 1-2,5	 spelatura cavetti rigidi e flessibili rigid and flexible wires stripping 9-10		

Marchi di qualità

Quality marks

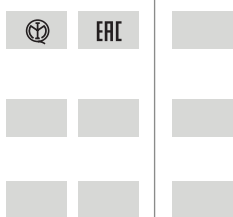

Direttive Europee

European directives

Conforme "RoHS"
"RoHS" compliant
Non soggetto alla "RAEE"
Not subject to "WEEE"

Pesi e confezioni

Weights and packaging

Art. Codice prodotti Product references	g Peso netto Net weight	n° pz per sacco per bag	n° pz per scatola per box	n° pz per cartone per carton
652/A	23,6	250	100	

Note La temperatura massima di funzionamento T è la massima temperatura ambiente alla quale il connettore può funzionare con il valore di corrente nominale indicato (EN/IEC61984). Limite di temperatura inferiore / superiore: -10 °C / +110 °C (EN/IEC61984).

Notes The maximum operating temperature T is the maximum ambient temperature for the connector working at the rated current value indicated (EN/IEC61984). Temperature lower/upper limits: -10 °C / +110 °C (EN/IEC61984).