

206/SC

206/SC-TF

**PORTALAMPADE PER LAMPADE AD INCANDESCENZA TUNGSTENO ALOGENE A TENSIONE DI RETE
LAMPHOLDER FOR MAIN VOLTAGE TUNGSTEN HALOGEN INCANDESCENT LAMP**

Dati tecnici

Technical data





| | |
|---|---------|
| - Attacco lampada - Lamp Cap | R7s |
| - Corrente e tensione nominale - Rated current and voltage | 6A-250V |
| - Temperatura massima di funzionamento (IEC) - Maximum operating temperature (IEC) | T300 |
| - Categoria di sovratensione - Impulse withstand category | III |

Caratteristiche

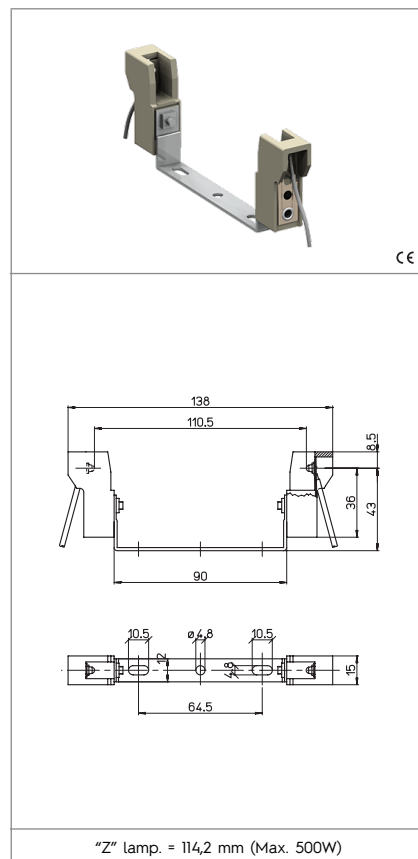
Characteristics

- Staffa in acciaio zincato isolata in classe II
- Zinc plated steel class II insulated support



| | | | |
|--|---|--|--|
|  fissaggio con vite screw fixing |  conduttore aggraffato al contatto conductor crimped to the contact |  sezione conduttore flessibile con fascetta section of the flexible conductor with ferrule |  sezione conduttore flessibile con fascetta section of the flexible conductor with ferrule |
|  lunghezza cavetto flessibile flexible wire length 25 cm | | | |
| | | | |

Marchi di qualità

Quality marks

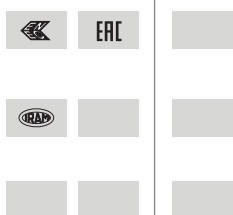

Direttive Europee

European directives

Conforme "RoHS"
"RoHS" compliant
Non soggetto alla "RAEE"
Not subject to "WEEE"

Pesi e confezioni

Weights and packaging

| Art. Codice prodotti Product references | g Peso netto Net weight | n° pz per sacco per bag | n° pz per scatola per box | n° pz per cartone per carton |
|---|-------------------------------|-------------------------------|---------------------------------|------------------------------------|
| 206/SC | 71,5 | | 20 | |
| 206/SC-TF | 70,3 | | 20 | |
| | | | | |
| | | | | |
| | | | | |
| | | | | |
| | | | | |

Note

Notes

Note

Note

ARTICOLI IN STEATITE

I particolari in steatite, in fase di cottura, subiscono variazioni dimensionali tra lotto e lotto di produzione perciò occorre fare riferimento alle tolleranze di lavorazione stabilite dalla norma DIN 40680, valori medi, rispetto alle quote nominali indicate a catalogo.

ARTICLES IN STEATITE

Products moulded in steatite undergo dimensional changes during the high temperature curing process. Therefore reference must be made to the tolerance stated in DIN 40680, middle values referred to the nominal values stated in the catalogue.

| DIMENSIONI DIMENSIONS | Tolleranza/Tolerance |
|--|-----------------------------|
| | DIN40680 |
| Fino a/Up to 4 | ±0,15 |
| Da/From 4,1 a/to 6 | ±0,20 |
| Da/From 6,1 a/to 8 | ±0,25 |
| Da/From 8,1 a/to 10 | ±0,30 |
| Da/From 10,1 a/to 13 | ±0,35 |
| Da/From 13,1 a/to 16 | ±0,40 |
| Da/From 16,1 a/to 20 | ±0,45 |
| Da/From 20,1 a/to 25 | ±0,50 |
| Da/From 25,1 a/to 30 | ±0,55 |
| Da/From 30,1 a/to 35 | ±0,60 |
| Da/From 35,1 a/to 40 | ±0,65 |
| Da/From 40,1 a/to 45 | ±0,70 |
| Da/From 45,1 a/to 50 | ±0,80 |
| Da/From 50,1 a/to 55 | ±0,90 |
| Da/From 55,1 a/to 60 | ±1,00 |