

AR5120/SV

AR5120/TF

AR5120/TF-FEP

PORTALAMPADE PER LAMPADRE AD INCANDESCENZA TUNGSTENO ALOGENE A TENSIONE DI RETE LAMPHOLDER FOR MAIN VOLTAGE TUNGSTEN HALOGEN INCANDESCENT LAMP

Dati tecnici

Technical data

- Attacco lampada - Lamp Cap	R7s
- Corrente e tensione nominale - Rated current and voltage	6A-250V
- Temperatura massima di funzionamento (IEC) - Maximum operating temperature (IEC)	T350
- Grado di protezione - Protection index	IP20





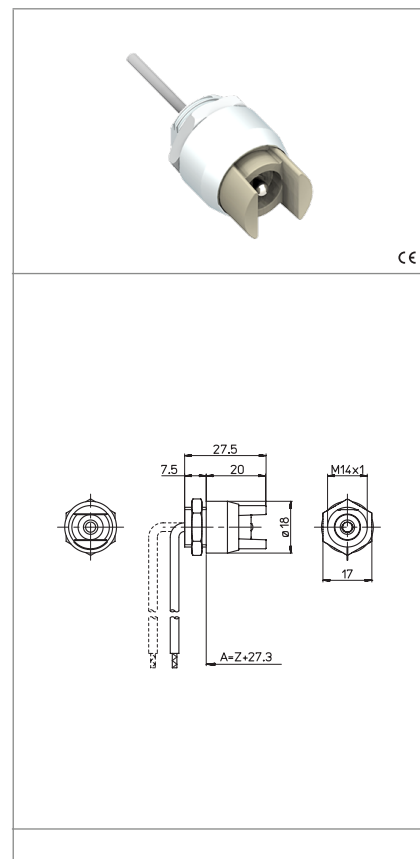

Caratteristiche

Characteristics

con dado di fissaggio M14x1
with M14x1 fixing nut

- Corpo in alluminio
- Aluminium body
- Contatto in CuNiZn (alpacca)
- CuNiZn (German silver) contact



 fissaggio con dado fixing with nut	 conduttore aggraffato al contatto conductor crimped to the contact	 sezione conduttore flessibile con fascetta section of the flexible conductor with ferrule	 sezione conduttore flessibile con fascetta section of the flexible conductor with ferrule
 sezione conduttore flessibile con fascetta section of the flexible conductor with ferrule	 lunghezza cavetto flessibile flexible wire length		

Marchi di qualità

Quality marks

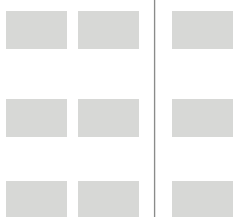

Direttive Europee

European directives

Conforme "RoHS"
"RoHS" compliant
Non soggetto alla "RAEE"
Not subject to "WEEE"

Pesi e confezioni

Weights and packaging

Art. Codice prodotti Product references	g Peso netto Net weight	n° pz per sacco per bag	n° pz per scatola per box	n° pz per cartone per carton
AR5120/SV	20		500	
AR5120/TF	19		500	
AR5120/TF-FEP	18,4		500	

Note

Notes