

9500-3/B-ST5-E

9500-3/W2-ST5-E

BINARIO TRIMLESS A 4 CONDUTTORI A BASSA TENSIONE
RECESSED LOW VOLTAGE 4 CONDUCTORS TRACK

Dati tecnici

Technical data

- Corrente e tensione nominale - Rated current and voltage	15A/60V dc







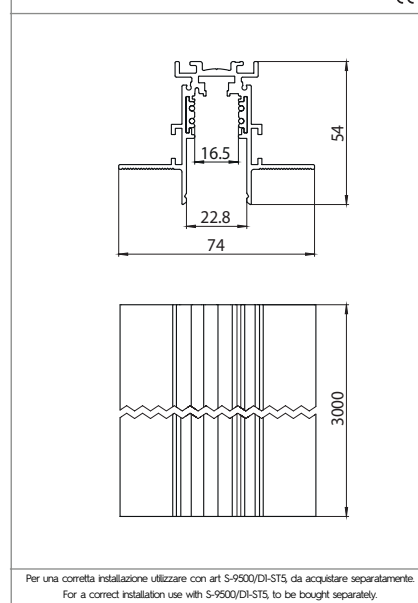





Caratteristiche

Characteristics

2 circuiti: 2x +/- 15A/0-60Vdc 2 circuits: 2x +/- 15A/0-60V dc
1 circuito + Data Bus: +/- 15A/0-60Vdc + D+/D- 1 circuit + Data Bus: +/- 15A/0-60V + D+/D-
- Lunghezza: 3000 mm - Length: 3000 mm
- Estruso esterno in alluminio. Colori disponibili: anodizzato nero (B); verniciato bianco RAL 9016 (W2) - External extruded body in aluminium. Available colours: anodized black (B) and painted white RAL 9016 (W2)
- Estruso isolante in PVC - Insulated extruded body in PVC
- Conduttori in rame - Copper conductors



Per una corretta installazione utilizzare con art S-9500/DI-ST5, da acquistare separatamente.
For a correct installation use with S-9500/DI-ST5, to be bought separately.

 Fissaggio trimless Trimless fixing	 classe III class III	 9504/ST2-...	 S-9500/DI-...
			
			

Marchi di qualità

Quality marks

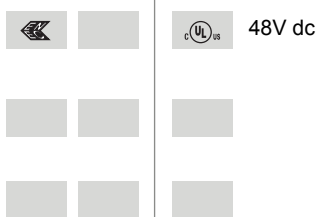

Direttive Europee

European directives

Conforme "RoHS"
"RoHS" compliant

Pesi e confezioni

Weights and packaging

Art. Codice prodotti Product references	g Peso netto Net weight	n° pz per sacco per bag	n° pz per scatola per box	n° pz per cartone per carton
9500-3/B-ST5-E				
9500-3/W2-ST5-E				

Note Binari per utilizzo in versione sia polarizzata che non polarizzata

Notes Track for both polarized and non polarized versions