

## 211-21/SC

### PORTALAMPADE PER LAMPADE A SCARICA AI VAPORI D'ALOGENURI LAMPHOLDER FOR HALIDE VAPOUR DISCHARGE LAMPS

#### Dati tecnici

##### Technical data





- Attacco lampada - Lamp Cap	RX7s RX7s-24
- Corrente e tensione nominale - Rated current and voltage	4A-250V
- Temperatura massima di funzionamento (IEC) - Maximum operating temperature (IEC)	T250
- Grado di protezione - Protection index	IP20
- Categoria di sovratensione - Impulse withstand category	III

#### Caratteristiche

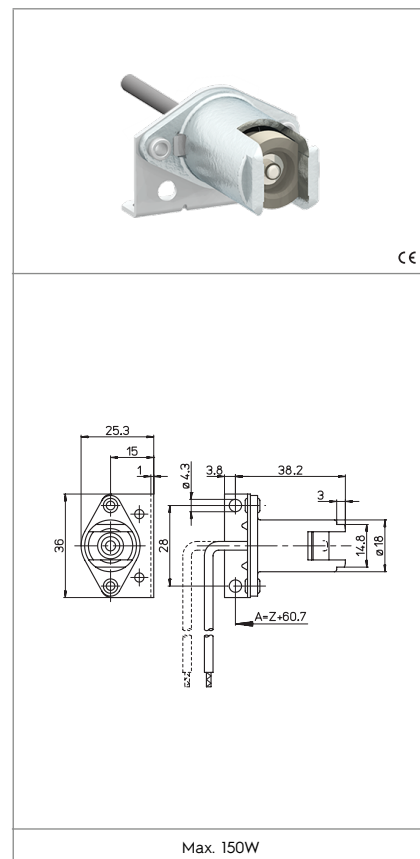
##### Characteristics

- Corpo in alluminio  
- Aluminium body
- Passacavo in PPS nero (T1= 240 °C)  
- Black PPS cable protection (T1= 240 °C)
- Contatto in nichel  
- Nickel contact



 fissaggio con vite screw fixing	 conduttore saldato elettricamente al contatto conductor electrically spot-welded to the contact	 sezione conduttore flessibile con fascetta section of the flexible conductor with ferrule	 lunghezza cavetto flessibile flexible wire length
 adatto per tensione di accensione ad impulsi fino a... suitable for impulse ignition voltage up to... 5kV			

#### Marchi di qualità

##### Quality marks

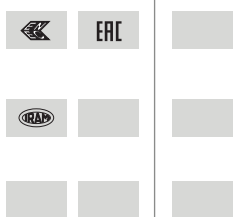

#### Direttive Europee

##### European directives

Conforme "RoHS"  
"RoHS" compliant  
Non soggetto alla "RAEE"  
Not subject to "WEEE"

#### Pesi e confezioni

##### Weights and packaging

Art. Codice prodotti Product references	g Peso netto Net weight	n° pz per sacco per bag	n° pz per scatola per box	n° pz per cartone per carton
211-21/SC	25,1		100	

#### Note

##### Notes