

**305**  
**305/S**

**305/DS**  
**305/S-DS**

**305/DTT**  
**305/S-DTT**

**PORTALAMPADE PER LAMPADE A SCARICA AI VAPORI D'ALOGENURI**  
**LAMPHOLDER FOR HALIDE VAPOUR DISCHARGE LAMPS**

**Dati tecnici**

Technical data

- Attacco lampada - Lamp Cap	G12
- Corrente e tensione nominale - Rated current and voltage	4A-1000V
- Temperatura massima di funzionamento (IEC) - Maximum operating temperature (IEC)	T250
- Grado di protezione - Protection index	IP20
- Categoria di sovratensione - Impulse withstand category	II





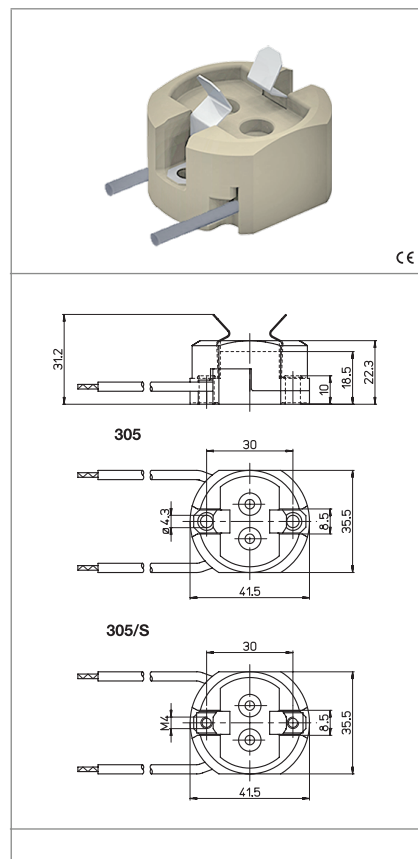

**Caratteristiche**

Characteristics

.../S= con bussole filettate M4  
.../S= with M4 threaded bushes

- Corpo in steatite  
- Steatite body
- Contatti in nichel  
- Nickel contacts



 fissaggio con vite screw fixing	 conduttore saldato elettricamente al contatto conductor electrically spot-welded to the contact	 sezione conduttore flessibile con fascetta section of the flexible conductor with ferrule	 sezione conduttore flessibile con fascetta section of the flexible conductor with ferrule
 sezione conduttore flessibile con fascetta section of the flexible conductor with ferrule DTT 0,75	 lunghezza cavetto flessibile flexible wire length 20 cm	 adatto per tensione di accensione ad impulsi fino a... suitable for impulse ignition voltage up to... 5kV	

**Marchi di qualità**  
Quality marks



**Direttive Europee**  
European directives

Conforme "RoHS"  
"RoHS" compliant  
Non soggetto alla "RAEE"  
Not subject to "WEEE"

**Pesi e confezioni**  
Weights and packaging

Art. Codice prodotti Product references	g Peso netto Net weight	n° pz per sacco per bag	n° pz per scatola per box	n° pz per cartone per carton
305	64,1		20	
305/DS	67		20	
305/DTT	62,6		20	
305/S	65,7		20	
305/S-DS	68,6		20	
305/S-DTT	64,2		20	

**Note**

Notes

**Note**

Note

**ARTICOLI IN STEATITE**

I particolari in steatite, in fase di cottura, subiscono variazioni dimensionali tra lotto e lotto di produzione perciò occorre fare riferimento alle tolleranze di lavorazione stabilite dalla norma DIN 40680, valori medi, rispetto alle quote nominali indicate a catalogo.

**ARTICLES IN STEATITE**

*Products moulded in steatite undergo dimensional changes during the high temperature curing process. Therefore reference must be made to the tolerance stated in DIN 40680, middle values referred to the nominal values stated in the catalogue.*

<b>DIMENSIONI DIMENSIONS</b>	<b>Tolleranza/Tolerance</b>
	<b>DIN40680</b>
Fino a/Up to 4	±0,15
Da/From 4,1 a/to 6	±0,20
Da/From 6,1 a/to 8	±0,25
Da/From 8,1 a/to 10	±0,30
Da/From 10,1 a/to 13	±0,35
Da/From 13,1 a/to 16	±0,40
Da/From 16,1 a/to 20	±0,45
Da/From 20,1 a/to 25	±0,50
Da/From 25,1 a/to 30	±0,55
Da/From 30,1 a/to 35	±0,60
Da/From 35,1 a/to 40	±0,65
Da/From 40,1 a/to 45	±0,70
Da/From 45,1 a/to 50	±0,80
Da/From 50,1 a/to 55	±0,90
Da/From 55,1 a/to 60	±1,00