

310-1/VI

PORTALAMPADE PER LAMPADE A SCARICA SODIO ALTA PRESSIONE LAMPHOLDER FOR SODIUM VAPOUR DISCHARGE LAMPS

Dati tecnici

Technical data





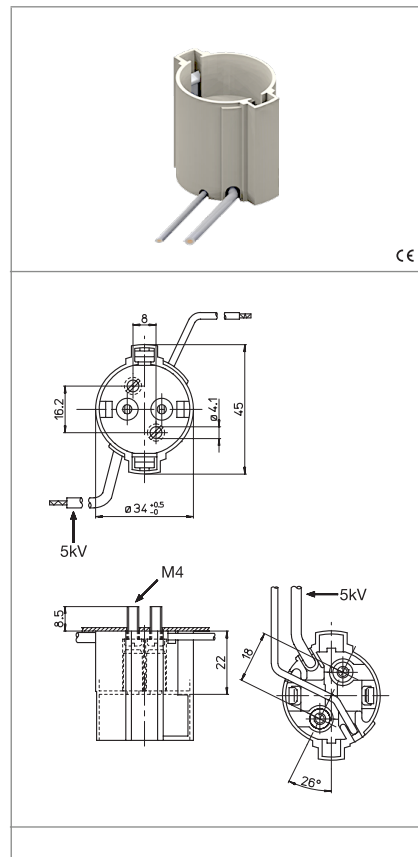

- Attacco lampada - Lamp Cap	PGI2-1
- Corrente e tensione nominale - Rated current and voltage	4A-500V
- Temperatura massima di funzionamento (IEC) - Maximum operating temperature (IEC)	T200
- Grado di protezione - Protection index	IP20
- Categoria di sovratensione - Impulse withstand category	III

Caratteristiche

Characteristics

- Corpo in PET naturale
- Natural PET body
- Contatti in nichel
- Nickel contacts
- Distanze superficiali: 10 mm
- Creepage distances: 10 mm



 fissaggio con vite screw fixing	 conduttore saldato elettricamente al contatto conductor electrically spot-welded to the contact	 sezione conduttore flessibile con fascetta section of the flexible conductor with ferrule	 sezione conduttore flessibile con fascetta section of the flexible conductor with ferrule
 lunghezza cavetto flessibile flexible wire length 20 cm	 adatto per tensione di accensione ad impulsi fino a... suitable for impulse ignition voltage up to... 5kV		

Marchi di qualità

Quality marks



Direttive Europee

European directives

Conforme "RoHS"
"RoHS" compliant
Non soggetto alla "RAEE"
Not subject to "WEEE"

Pesi e confezioni

Weights and packaging

Art. Codice prodotti Product references	g Peso netto Net weight	n° pz per sacco per bag	n° pz per scatola per box	n° pz per cartone per carton
310-1/VI	33,3		50	

Note

Notes