

212

212/TF-FEP

**PORTALAMPADE PER LAMPADE AD INCANDESCENZA TUNGSTENO ALOGENE A BASSISSIMA TENSIONE
LAMPHOLDER FOR EXTRA LOW VOLTAGE TUNGSTEN HALOGEN INCANDESCENT LAMPS**

Dati tecnici

Technical data

- Attacco lampada - Lamp Cap	G4 GY4
- Corrente e tensione nominale - Rated current and voltage	3A-24V
- Temperatura massima di funzionamento (IEC) - Maximum operating temperature (IEC)	T200
- Grado di protezione - Protection index	IP20
- Categoria di sovratensione - Impulse withstand category	II





Caratteristiche

Characteristics

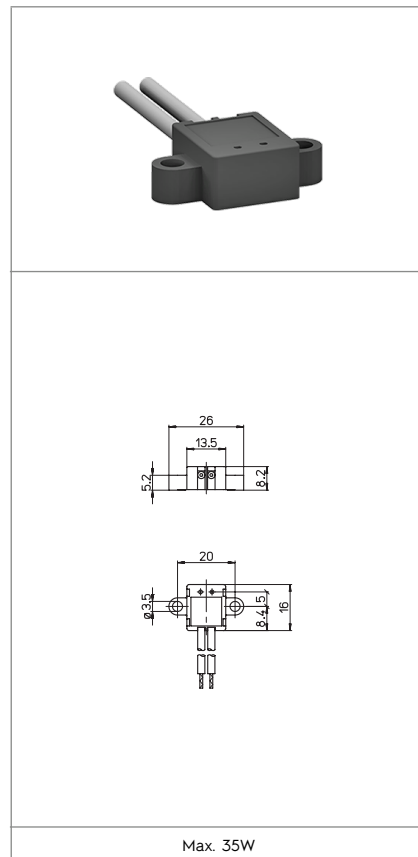
CONNETTORI CON GY4
CONNECTORS WITH GY4

- Corpo in PPS nero (Tl= 240 °C)
- Black PPS body (Tl= 240 °C)
- Doppi contatti in nichel
- Nickel twin contacts



 fissaggio con vite screw fixing	 conduttore aggraffato al contatto conductor crimped to the contact	 sezione conduttore flessibile con fascetta section of the flexible conductor with ferrule	 sezione conduttore flessibile con fascetta section of the flexible conductor with ferrule
 lunghezza cavetto flessibile flexible wire length 12 cm			

Marchi di qualità

Quality marks

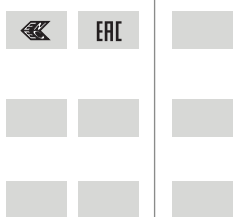

Direttive Europee

European directives

Conforme "RoHS"
"RoHS" compliant
Non soggetto alla "RAEE"
Not subject to "WEEE"

Pesi e confezioni

Weights and packaging

Art. Codice prodotti Product references	g Peso netto Net weight	n° pz per sacco per bag	n° pz per scatola per box	n° pz per cartone per carton
212	5,2		500	
212/TF-FEP	4,9		500	

Note

Notes