

**226/Z**

**226/Z-TF**

**226/Z-TF-FEP**

**226/Z-DS**

**226/Z-DT**

**PORTALAMPADE PER LAMPADRE AD INCANDESCENZA TUNGSTENO ALOGENE A TENSIONE DI RETE  
LAMPHOLDER FOR MAIN VOLTAGE TUNGSTEN HALOGEN INCANDESCENT LAMP**

**Dati tecnici**

Technical data

- Attacco lampada - Lamp Cap	GU10 GZ10
- Corrente e tensione nominale - Rated current and voltage	2A-250V
- Temperatura massima di funzionamento (IEC) - Maximum operating temperature (IEC)	T250
- Grado di protezione - Protection index	IP20
- Categoria di sovratensione - Impulse withstand category	II







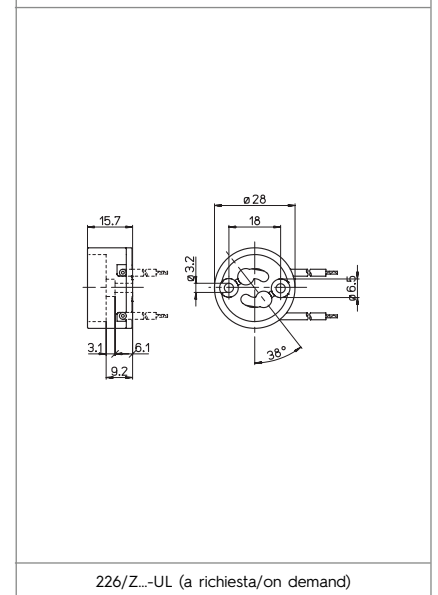

**Caratteristiche**

Characteristics

- Corpo in steatite  
- Steatite body
- Base in PPS nero (TI= 240 °C)  
- Black PPS base (TI= 240 °C)
- Contatti in nichel  
- Nickel contacts



226/Z...-UL (a richiesta/on demand)

 fissaggio con vite screw fixing	 conduttore saldato elettricamente al contatto conductor electrically spot-welded to the contact	 sezione conduttore flessibile con fascetta section of the flexible conductor with ferrule	 sezione conduttore flessibile con fascetta section of the flexible conductor with ferrule
 sezione conduttore flessibile con fascetta section of the flexible conductor with ferrule	 sezione conduttore flessibile con fascetta section of the flexible conductor with ferrule	 sezione conduttore flessibile con fascetta section of the flexible conductor with ferrule	 lunghezza cavetto flessibile flexible wire length 14 cm
 118/...			

**Marchi di qualità**

Quality marks



**Direttive Europee**

European directives

Conforme "RoHS"  
"RoHS" compliant  
Non soggetto alla "RAEE"  
Not subject to "WEEE"

**Pesi e confezioni**

Weights and packaging

Art. Codice prodotti Product references	g Peso netto Net weight	n° pz per sacco per bag	n° pz per scatola per box	n° pz per cartone per carton
226/Z	17,7		200	
226/Z-TF	17		200	
226/Z-TF-FEP	16,7		200	
226/Z-DS	20,3		200	
226/Z-DT	17,3		200	600

**Note**

Notes

**Note**

Note

**ARTICOLI IN STEATITE**

I particolari in steatite, in fase di cottura, subiscono variazioni dimensionali tra lotto e lotto di produzione perciò occorre fare riferimento alle tolleranze di lavorazione stabilite dalla norma DIN 40680, valori medi, rispetto alle quote nominali indicate a catalogo.

**ARTICLES IN STEATITE**

*Products moulded in steatite undergo dimensional changes during the high temperature curing process. Therefore reference must be made to the tolerance stated in DIN 40680, middle values referred to the nominal values stated in the catalogue.*

<b>DIMENSIONI</b> <b>DIMENSIONS</b>	<b>Tolleranza/Tolerance</b>
	<b>DIN40680</b>
Fino a/Up to 4	±0,15
Da/From 4,1 a/to 6	±0,20
Da/From 6,1 a/to 8	±0,25
Da/From 8,1 a/to 10	±0,30
Da/From 10,1 a/to 13	±0,35
Da/From 13,1 a/to 16	±0,40
Da/From 16,1 a/to 20	±0,45
Da/From 20,1 a/to 25	±0,50
Da/From 25,1 a/to 30	±0,55
Da/From 30,1 a/to 35	±0,60
Da/From 35,1 a/to 40	±0,65
Da/From 40,1 a/to 45	±0,70
Da/From 45,1 a/to 50	±0,80
Da/From 50,1 a/to 55	±0,90
Da/From 55,1 a/to 60	±1,00