

**347/F**

**347/M**

**348/F**

**PORTALAMPADE A PASTIGLIA PER LAMPADE FLUORESCENTI LINEARI T8-T12  
ROUND LAMPHOLDER FOR T8-T12 FLUORESCENT LINEAR LAMPS**

**Dati tecnici**

Technical data





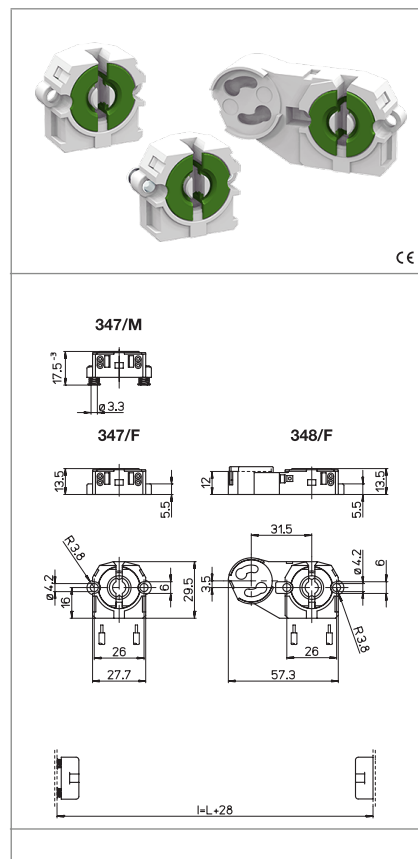

- Attacco lampada - Lamp Cap	G13
- Corrente e tensione nominale - Rated current and voltage	2A-250V
- Temperatura massima di funzionamento (IEC) - Maximum operating temperature (IEC)	T130 Tm110
- Grado di protezione - Protection index	IP20
- Categoria di sovratensione - Impulse withstand category	III

**Caratteristiche**

Characteristics

- Corpo in policarbonato bianco  
- White polycarbonate body
- Contatti in lega di rame  
- Copper alloy contacts



 fissaggio con vite, fisso fixing with screw, fixed	 fissaggio con vite, mobile fixing with screw, adjustable	 spessore thickness	 rotore in PBT verde con scatti di... PBT green rotor with position of...
 serrafilo automatico a 2 fori push-wire terminals with 2 holes	 sezione conduttori rigidi rigid conductor section	 spelatura cavetti rigidi rigid wires stripping	

**Marchi di qualità**

Quality marks

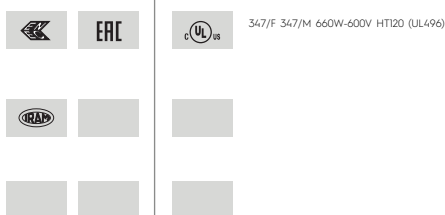

**Direttive Europee**

European directives

Conforme "RoHS"  
"RoHS" compliant  
Non soggetto alla "RAEE"  
Not subject to "WEEE"

**Pesi e confezioni**

Weights and packaging

Art. Codice prodotti Product references	g Peso netto Net weight	n° pz per sacco per bag	n° pz per scatola per box	n° pz per cartone per carton
347/F	6,1	1000	200	
347/M	6,9	1000		
348/F	10		200	

**Note**

Notes