

**650/CB**

**SEZIONATORE PRESA CON BLOCCACAVO**  
**SOCKET INSULATOR BLOCK WITH CABLE LOCK**

**Dati tecnici**

*Technical data*









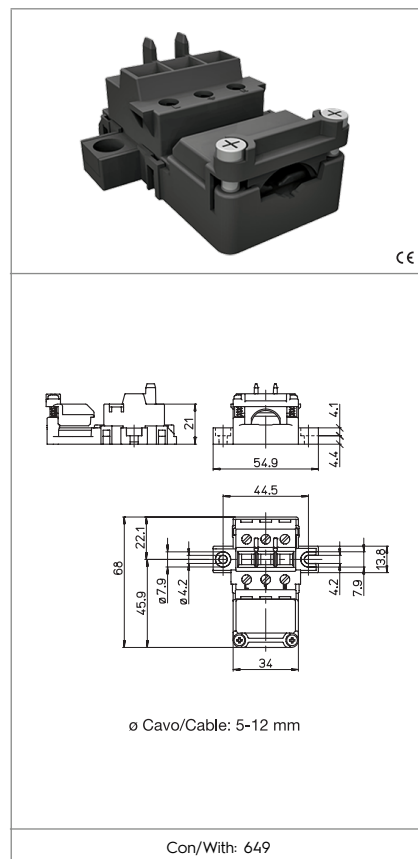

- Poli - Poles	3P
- Corrente e tensione nominale - Rated current and voltage	16A-400V
- Temperatura massima di funzionamento (IEC) - Maximum operating temperature (IEC)	T200

**Caratteristiche**

*Characteristics*

- Corpo in PET nero  
- Black PET body
- Contatti in bronzo fosforoso nichelato  
- Nickel plated phosphor bronze contacts



 fissaggio con vite screw fixing	 isolato in classe II class II insulated		
	 spelatura cavetti rigidi e flessibili con fascetta rigid and flexible with ferrule wires stripping 9-10	 serrafilo con vite e morsetto screw terminals 1-2,5	 entrata: vite uscita: vite input side: screw output side: screw
 serrafilo con vite e morsetto screw terminals 1-2,5	 spelatura cavetti rigidi e flessibili con fascetta rigid and flexible with ferrule wires stripping 9-10		

**Marchi di qualità**

*Quality marks*

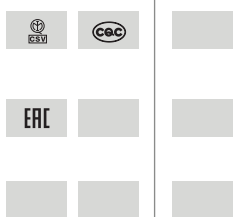

**Direttive Europee**

*European directives*

Conforme "RoHS"  
"RoHS" compliant  
Non soggetto alla "RAEE"  
Not subject to "WEEE"

**Pesi e confezioni**

*Weights and packaging*

Art. Codice prodotti Product references	g Peso netto Net weight	n° pz per sacco per bag	n° pz per scatola per box	n° pz per cartone per carton
650/CB	53,3			250

**Note**

*Notes*