

649

SEZIONATORE SPINA PLUG INSULATOR BLOCK

Dati tecnici

Technical data







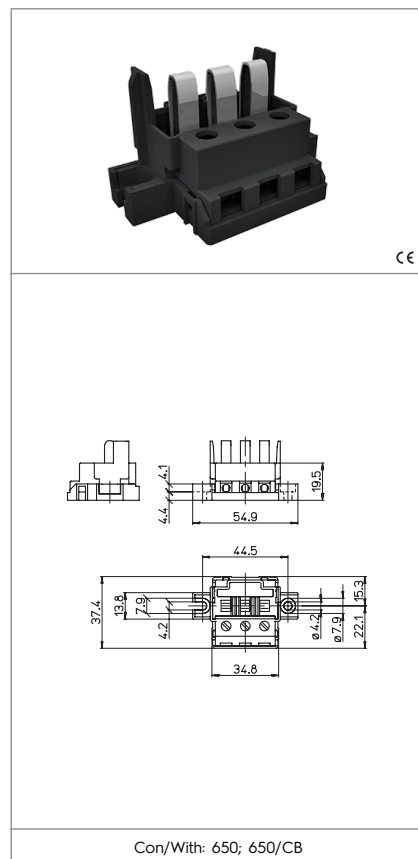

- Poli - Poles	3P
- Corrente e tensione nominale - Rated current and voltage	16A-400V
- Temperatura massima di funzionamento (IEC) - Maximum operating temperature (IEC)	T200

Caratteristiche

Characteristics

- Corpo in PET nero
- Black PET body
- Contatti in acciaio argentato
- Silver plated steel contacts



 fissaggio con vite screw fixing	 isolato in classe II class II insulated	
		
 serrafilo con vite e morsetto screw terminals 1-2,5	 spelatura cavetti rigidi e flessibili con fascetta rigid and flexible with ferrule wires stripping 9-10	

	 uscita: vite output side: screw
	

Marchi di qualità

Quality marks

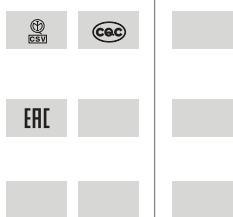

Direttive Europee

European directives

Conforme "RoHS"
"RoHS" compliant
Non soggetto alla "RAEE"
Not subject to "WEEE"

Pesi e confezioni

Weights and packaging

Art. Codice prodotti Product references	g Peso netto Net weight	n° pz per sacco per bag	n° pz per scatola per box	n° pz per cartone per carton
649	31,3	250		

Note

Notes