

661/V

MORSETTO CONNETTORE SPINA PLUG TERMINAL BLOCK

Dati tecnici

Technical data

- Poli - Poles	4P+E
- Corrente e tensione nominale - Rated current and voltage	6A-400V
- Temperatura massima di funzionamento (IEC) - Maximum operating temperature (IEC)	T65
- Grado di protezione - Protection index	IP20
- Cat. sovratensione / Grado di inquinamento - Impulse withstand cat. / Pollution degree	III / 2

Caratteristiche

Characteristics

- Corpo in policarbonato bianco
- White polycarbonate body
- Corpo serrafilo in ottone nichelato
- Internal part in nickel plated brass
- Connessione di terra in ottone nichelato
- Earth connection in nickel plated brass

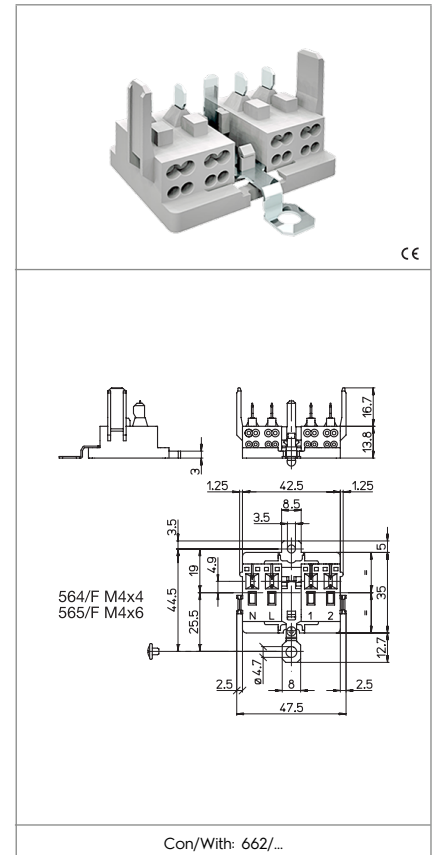



 fissaggio con vite
screw fixing

 adatto per tensione di accensione ad impulsi fino a...
suitable for impulse ignition voltage up to...

 564/F 565/F

 0,5-1,5
serrafilo automatico a 4 fori
push-wire terminals with 4 holes

 spelatura cavetti rigidi
rigid wires stripping

 uscita: automatico
output side: push wire

Marchi di qualità

Quality marks

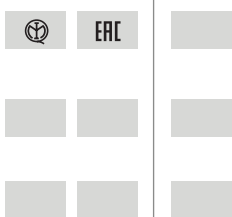

Direttive Europee

European directives

Conforme "RoHS"
"RoHS" compliant
Non soggetto alla "RAEE"
Not subject to "WEEE"

Pesi e confezioni

Weights and packaging

Art. Codice prodotti Product references	g Peso netto Net weight	n° pz per sacco per bag	n° pz per scatola per box	n° pz per cartone per carton
661/V	18,4	500		

Note La temperatura massima di funzionamento T è la massima temperatura ambiente alla quale il connettore può funzionare con il valore di corrente nominale indicato (EN/IEC61984). Limite di temperatura inferiore / superiore: -10 °C / +110 °C (EN/IEC61984).

Notes The maximum operating temperature T is the maximum ambient temperature for the connector working at the rated current value indicated (EN/IEC61984). Temperature lower/upper limits: -10 °C / +110 °C (EN/IEC61984).