

30/AU

**SUPPORTO
BRACKET**







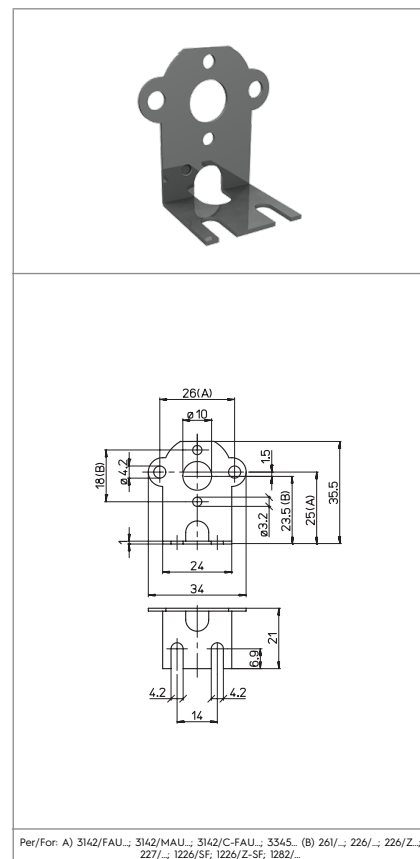





Dati tecnici
Technical data

Caratteristiche
Characteristics

in acciaio zincato
in zinc plated steel



Per/For: A) 3142/FAU.; 3142/MAU.; 3142/C-FAU.; 3345... (B) 261/... 226/... 226/Z... 227/... 1226/SF; 1226/Z-SF; 1282/...

	fissaggio con vite screw fixing			
				
				

Marchi di qualità
Quality marks

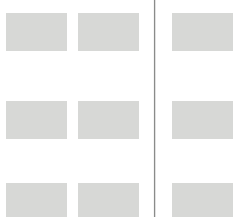

Direttive Europee
European directives

Conforme "RoHS"
"RoHS" compliant
Non soggetto alla "RAEE"
Not subject to "WEEE"

Pesi e confezioni
Weights and packaging

Art. Codice prodotti Product references	g Peso netto Net weight	n° pz per sacco per bag	n° pz per scatola per box	n° pz per cartone per carton
30/AU	8,3		200	

Note

Notes