

285/FAU-TR

285/MAU-TR

PORTALAMPADE A PASTIGLIA PER LAMPADE FLUORESCENTI LINEARI T5 ROUND LAMPHOLDER FOR T5 FLUORESCENT LINEAR LAMPS

Dati tecnici

Technical data







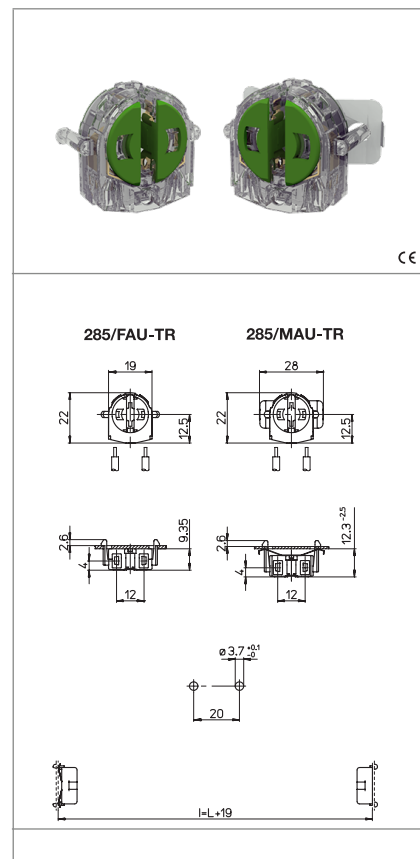

- Attacco lampada - Lamp Cap	G5
- Corrente e tensione nominale - Rated current and voltage	2A-500V
- Temperatura massima di funzionamento (IEC) - Maximum operating temperature (IEC)	T130 Tm110
- Grado di protezione - Protection index	IP20
- Categoria di sovratensione - Impulse withstand category	III

Caratteristiche

Characteristics

- Corpo in policarbonato trasparente
- Transparent polycarbonate body
- Contatti in lega di rame
- Copper alloy contacts
- Con top test
- With top test



 fissaggio ad innesto posteriore, fisso <i>back mounting, fixed</i>	 fissaggio ad innesto posteriore, mobile <i>back mounting, adjustable</i>	 spessore lamiera di fissaggio <i>fixing metal plate thickness</i> 0,6-1,2	 spessore <i>thickness</i> 9,35
 rotore in PBT verde con scatti di... <i>PBT green rotor with position of...</i> 90°	 serrafilo automatico a 2 fori <i>push-wire terminals with 2 holes</i>	 sezione conduttori rigidi <i>rigid conductor section</i> 0,5-1	 spelatura cavetti rigidi <i>rigid wires stripping</i> 8-9
 IP40 1115			

Marchi di qualità

Quality marks

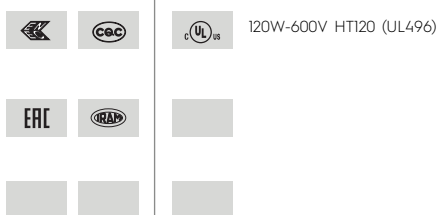

Direttive Europee

European directives

Conforme "RoHS"
"RoHS" compliant
Non soggetto alla "RAEE"
Not subject to "WEEE"

Pesi e confezioni

Weights and packaging

Art. Codice prodotti Product references	g Peso netto Net weight	n° pz per sacco per bag	n° pz per scatola per box	n° pz per cartone per carton
285/FAU-TR	2,9	1000		
285/MAU-TR	3,4	1000		

Note

Notes