

## 45I/FA

### PORTALAMPADE PER LAMPADE FLUORESCENTI COMPATTE (TC-SEL) LAMPHOLDER FOR COMPACT FLUORESCENT LAMPS (TC-SEL)

#### Dati tecnici

##### Technical data





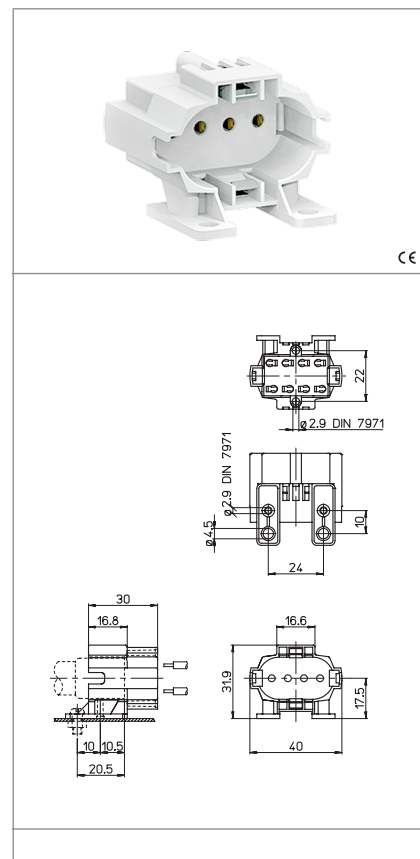

- Attacco lampada - Lamp Cap	2G7
- Corrente e tensione nominale - Rated current and voltage	2A-250V
- Temperatura massima di funzionamento (IEC) - Maximum operating temperature (IEC)	T140
- Grado di protezione - Protection index	IP20
- Categoria di sovratensione - Impulse withstand category	II

#### Caratteristiche

##### Characteristics

- Corpo in PBT bianco  
- White PBT body
- Contatti in lega di rame  
- Copper alloy contacts



 fissaggio con vite screw fixing	 altezza centro lampada (da sopra la lamiera) lamp centre height (from the top of the metal plate) 17,5	 serrafilo automatico a 2 fori push-wire terminals with 2 holes	 sezione conduttori rigidi rigid conductor section 0,5-1
 spelatura cavetti rigidi rigid wires stripping 8-9	 130	 S-45I/3	

#### Marchi di qualità

##### Quality marks

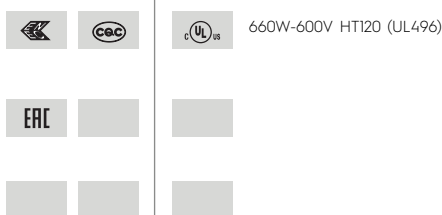

#### Direttive Europee

##### European directives

Conforme "RoHS"  
"RoHS" compliant  
Non soggetto alla "RAEE"  
Not subject to "WEEE"

#### Pesi e confezioni

##### Weights and packaging

Art. Codice prodotti Product references	g Peso netto Net weight	n° pz per sacco per bag	n° pz per scatola per box	n° pz per cartone per carton
45I/FA	15,2	500	100	

#### Note

##### Notes