

288/TR

PORTALAMPADE CONNETTORE PER LAMPADE FLUORESCENTI LINEARI T5 PUSH-ON LAMPHOLDER FOR T5 FLUORESCENT LINEAR LAMPS

Dati tecnici

Technical data





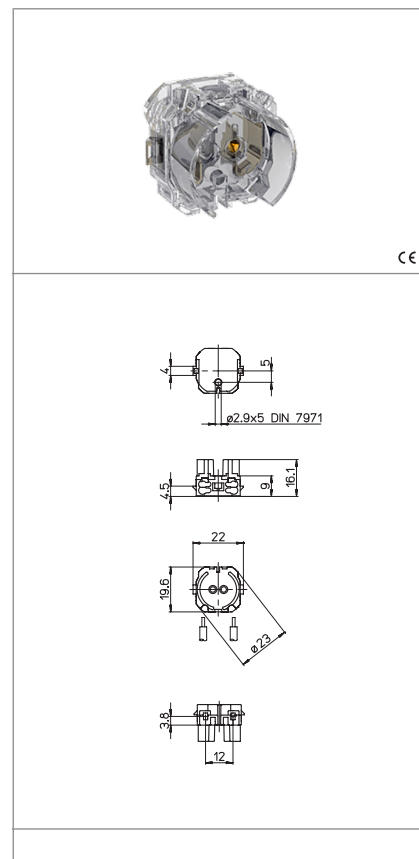

- Attacco lampada - Lamp Cap	G5
- Corrente e tensione nominale - Rated current and voltage	2A-500V
- Temperatura massima di funzionamento (IEC) - Maximum operating temperature (IEC)	T110
- Grado di protezione - Protection index	IP20
- Categoria di sovratensione - Impulse withstand category	III

Caratteristiche

Characteristics

- Corpo in policarbonato trasparente
- Transparent polycarbonate body
- Contatti in lega di rame
- Copper alloy contacts
- Con top test
- With top test



 fissaggio diretto sulla lampada push fixing on the lamp	 spessore thickness	 serrafilo automatico a 2 fori push-wire terminals with 2 holes	 sezione conduttori rigidi rigid conductor section
 spelatura cavetti rigidi rigid wires stripping	 36 136		

Marchi di qualità

Quality marks

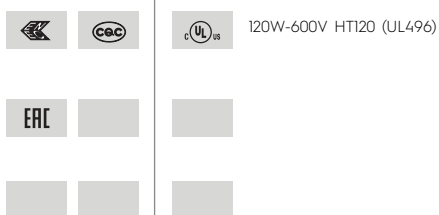

Direttive Europee

European directives

Conforme "RoHS"
"RoHS" compliant
Non soggetto alla "RAEE"
Not subject to "WEEE"

Pesi e confezioni

Weights and packaging

Art. Codice prodotti Product references	g Peso netto Net weight	n° pz per sacco per bag	n° pz per scatola per box	n° pz per cartone per carton
288/TR	3,1	1000		

Note L'apparecchio di illuminazione deve essere sottoposto a tutte le prove relative alla sicurezza contro il contatto accidentale durante il cambio della lampada previste dalle norme EN/IEC 60598.

Notes All luminaires must undergo to all safety tests to protect against electric shock during the lamp replacement operation as prescribed by the EN/IEC 60598 standards.