

265/TR

**PORTALAMPADE A COLONNA PER LAMPADE FLUORESCENTI LINEARI T5
TOMBSTONE LAMPHOLDER FOR T5 FLUORESCENT LINEAR LAMPS**

Dati tecnici

Technical data







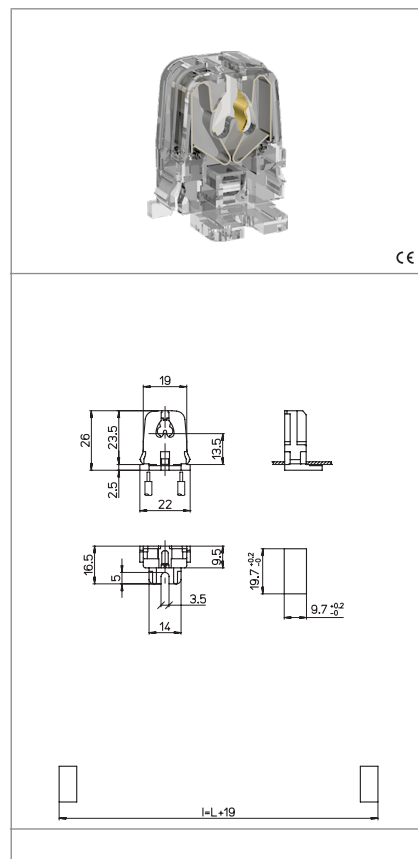

- Attacco lampada - Lamp Cap	G5
- Corrente e tensione nominale - Rated current and voltage	2A-500V
- Temperatura massima di funzionamento (IEC) - Maximum operating temperature (IEC)	T110
- Grado di protezione - Protection index	IP20
- Categoria di sovratensione - Impulse withstand category	III

Caratteristiche

Characteristics

- Corpo in policarbonato trasparente
- Transparent polycarbonate body
- Contatti in lega di rame
- Copper alloy contacts



 fissaggio ad inserimento push-through fixing	 spessore lamiera di fissaggio fixing metal plate thickness 0,6-1,2	 altezza centro lampada (da sotto la lamiera) lamp centre height (from the bottom of the metal plate) 13,5	 fissaggio con vite screw fixing
 altezza centro lampada (da sopra la lamiera) lamp centre height (from the top of the metal plate) 16	 serrafilo automatico ad 1 foro push-wire terminals with 1 hole	 sezione conduttori rigidi rigid conductor section 0,5-1	 spelatura cavetti rigidi rigid wires stripping 10-11

Marchi di qualità

Quality marks

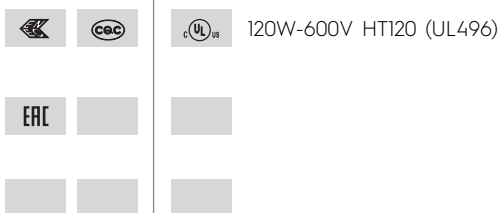

Direttive Europee

European directives

Conforme "RoHS"
"RoHS" compliant
Non soggetto alla "RAEE"
Not subject to "WEEE"

Pesi e confezioni

Weights and packaging

Art. Codice prodotti Product references	g Peso netto Net weight	n° pz per sacco per bag	n° pz per scatola per box	n° pz per cartone per carton
265/TR	3,3	1000		

Note

Notes