

82/F







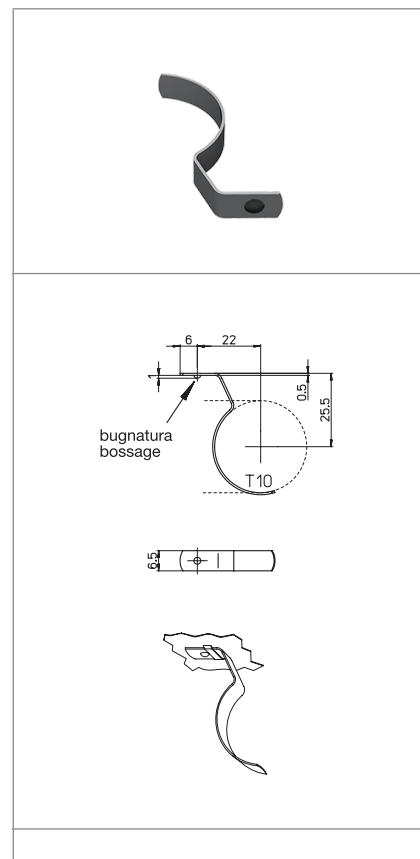

GANCIO CON BUGNATURA
CLIP WITH BOSSAGE

Dati tecnici
Technical data

Caratteristiche
Characteristics

in acciaio nichelato
in nickel plated steel



		<p>altezza centro lampada (da sopra la lamiera) <i>lamp centre height (from the top of the metal plate)</i></p>	
			
			

Marchi di qualità
Quality marks

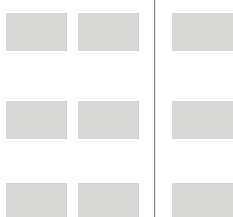

Direttive Europee
European directives

Conforme "RoHS"
"RoHS" compliant
Non soggetto alla "RAEE"
Not subject to "WEEE"

Pesi e confezioni
Weights and packaging

Art. Codice prodotti <i>Product references</i>	g Peso netto <i>Net weight</i>	n° pz per sacco <i>per bag</i>	n° pz per scatola <i>per box</i>	n° pz per cartone <i>per carton</i>
82/F	1,6	500		

Note

Notes