

289/F-21-TR

289/F-25-TR

289/F-30-TR

289/F-36-TR

**PORTALAMPADE A COLONNA PER LAMPADE FLUORESCENTI LINEARI T5
TOMBSTONE LAMPHOLDER FOR T5 FLUORESCENT LINEAR LAMPS**

Dati tecnici

Technical data

- Attacco lampada - Lamp Cap	G5
- Corrente e tensione nominale - Rated current and voltage	2A-500V
- Temperatura massima di funzionamento (IEC) - Maximum operating temperature (IEC)	T130 Tm110
- Grado di protezione - Protection index	IP20
- Categoria di sovratensione - Impulse withstand category	III







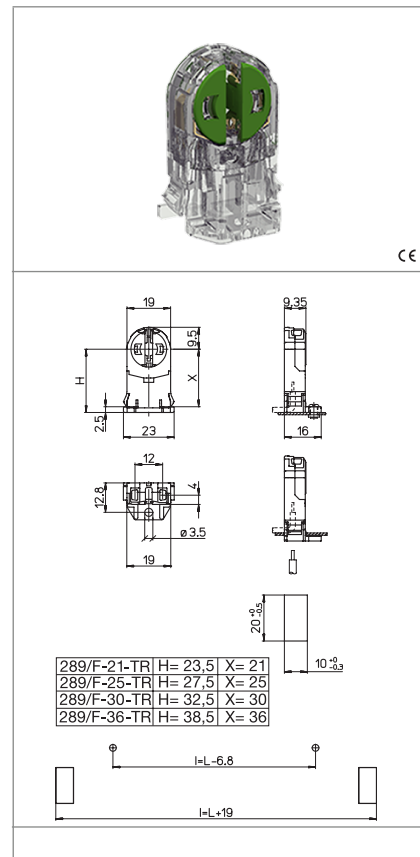

Caratteristiche

Characteristics

- Corpo in policarbonato trasparente
- Transparent polycarbonate body
- Contatti in lega di rame
- Copper alloy contacts
- Con top test
- With top test



289/F-21-TR	H= 23,5	X= 21
289/F-25-TR	H= 27,5	X= 25
289/F-30-TR	H= 32,5	X= 30
289/F-36-TR	H= 38,5	X= 36

 fissaggio con vite screw fixing	 altezza centro lampada (da sopra la lamiera) lamp centre height (from the top of the metal plate)	 fissaggio ad inserimento push-through fixing	 spessore lamiera di fissaggio fixing metal plate thickness 0,4-2
 altezza centro lampada (da sotto la lamiera) lamp centre height (from the bottom of the metal plate)	 rotore in PBT verde con scatti di... PBT green rotor with position of... 90°	 serrafilo automatico a 2 fori push-wire terminals with 2 holes	 sezione conduttori rigidi rigid conductor section 0,5-1
 spelatura cavetti rigidi rigid wires stripping 8-9			

Marchi di qualità

Quality marks

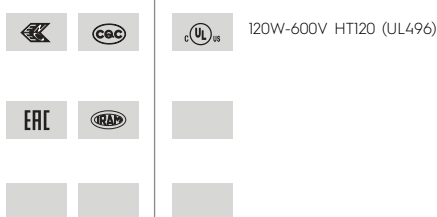

Direttive Europee

European directives

Conforme "RoHS"
"RoHS" compliant
Non soggetto alla "RAEE"
Not subject to "WEEE"

Pesi e confezioni

Weights and packaging

Art. Codice prodotti Product references	g Peso netto Net weight	n° pz per sacco per bag	n° pz per scatola per box	n° pz per cartone per carton
289/F-21-TR	3,9	1000		
289/F-25-TR	4	1000		
289/F-30-TR	4,4	1000		
289/F-36-TR	4,8	1000		

Note

Notes