

1305

1305/DS

1305/DTT

PORTALAMPADE PER LAMPADE A SCARICA AI VAPORI D'ALOGENURI
LAMPHOLDER FOR HALIDE VAPOUR DISCHARGE LAMPS

Dati tecnici

Technical data





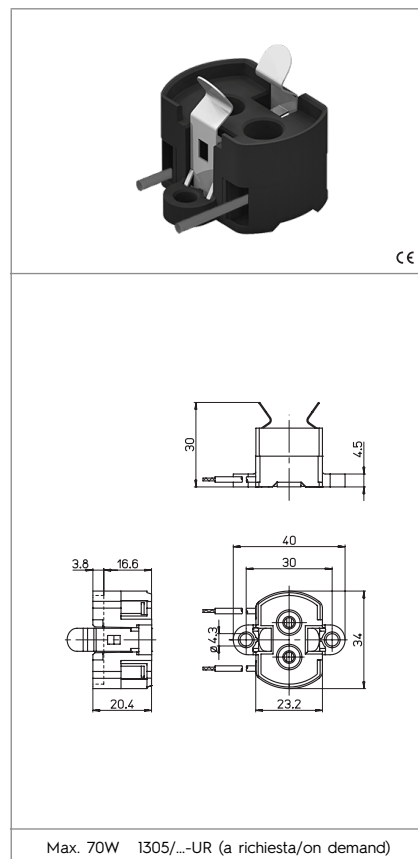

- Attacco lampada - Lamp Cap	G12
- Corrente e tensione nominale - Rated current and voltage	2A-250V
- Temperatura massima di funzionamento (IEC) - Maximum operating temperature (IEC)	T250
- Grado di protezione - Protection index	IP20
- Categoria di sovratensione - Impulse withstand category	III

Caratteristiche

Characteristics

- Corpo in LCP nero
- Black LCP body
- Contatti in nichel
- Nickel contacts



 fissaggio con vite screw fixing	 conduttore saldato elettricamente al contatto conductor electrically spot-welded to the contact	 sezione conduttore flessibile con fascetta section of the flexible conductor with ferrule	 sezione conduttore flessibile con fascetta section of the flexible conductor with ferrule
 sezione conduttore flessibile con fascetta section of the flexible conductor with ferrule DTT 0,75	 lunghezza cavetto flessibile flexible wire length 20 cm	 adatto per tensione di accensione ad impulsi fino a... suitable for impulse ignition voltage up to... 5kV	

Marchi di qualità

Quality marks



Direttive Europee

European directives

Conforme "RoHS"
"RoHS" compliant
Non soggetto alla "RAEE"
Not subject to "WEEE"

Pesi e confezioni

Weights and packaging

Art. Codice prodotti Product references	g Peso netto Net weight	n° pz per sacco per bag	n° pz per scatola per box	n° pz per cartone per carton
1305	19,1		200	
1305/DS	22		200	
1305/DTT	17,6		200	

Note

Notes