

1602/VDB-M-5

1602/VDN-M-5

PRESE DI CONNESSIONE CON BASE E BLOCCACAPO
CONNECTION SOCKETS WITH BASE AND CABLE LOCK

Dati tecnici

Technical data









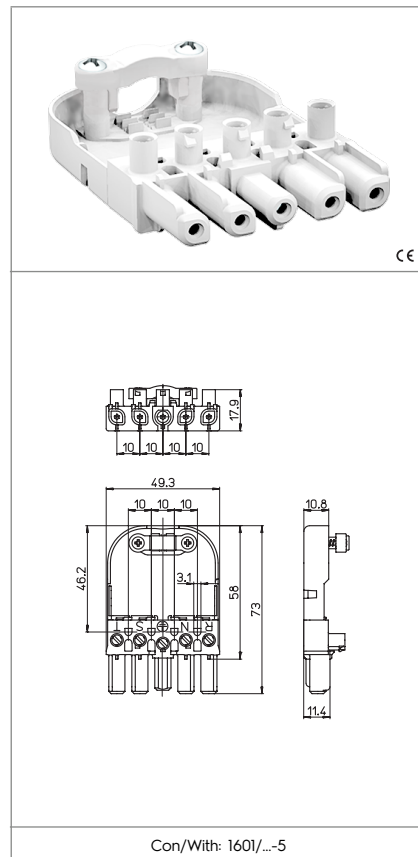



- Poli - Poles	4P+E
- Corrente e tensione nominale - Rated current and voltage	16A-400V
- Temperatura massima di funzionamento (IEC) - Maximum operating temperature (IEC)	T120
- Grado di protezione - Protection index	IP20
- Cat. sovratensione / Grado di inquinamento - Impulse withstand cat. / Pollution degree	III / 2

Caratteristiche

Characteristics

- Corpo in poliammide .../B= bianco .../N= nero
- Polyamide body .../B= white .../N= black
- Contatti in ottone argentato
- Silver plated brass contacts



 senza fissaggio without fixing	 fissaggio con vite screw fixing	 serrafilo con vite e morsetto screw terminals	 sezione conduttore flessibile section of the flexible conductor
 sezione conduttore flessibile con fascetta section of the flexible conductor with ferrule	 sezione conduttori rigidi rigid conductor section	 spelatura cavetti rigidi e flessibili (con o senza fascetta) rigid and flexible wires stripping (with or without ferrule)	
			

Marchi di qualità

Quality marks

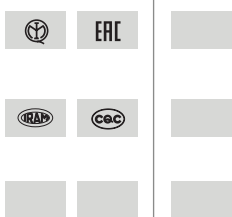

Direttive Europee

European directives

Conforme "RoHS"
"RoHS" compliant

Pesi e confezioni

Weights and packaging

Art. Codice prodotti Product references	g Peso netto Net weight	n° pz per sacco per bag	n° pz per scatola per box	n° pz per cartone per carton
1602/VDB-M-5	24,1	250		
1602/VDN-M-5	24,1	250		

Note - La temperatura massima di funzionamento T è la massima temperatura ambiente alla quale il connettore può funzionare con il valore di corrente nominale indicato (EN/IEC61984). Limite di temperatura inferiore / superiore è: -10 °C / +150 °C (EN/IEC61984).

Notes - The maximum operating temperature T is the maximum ambient temperature for the connector working at the rated current value indicated (EN/IEC61984). Temperature lower/upper limits: -10 °C / +150 °C (EN/IEC61984).