

**289/21-TR**

**289/N-21-TR**

**289/25-TR**

**289/N-25-TR**

**289/30-TR**

**289/N-30-TR**

**289/36-TR**

**289/N-36-TR**

**PORTALAMPADE A COLONNA PER LAMPADE FLUORESCENTI LINEARI T5  
TOMBSTONE LAMPHOLDER FOR T5 FLUORESCENT LINEAR LAMPS**

**Dati tecnici**

Technical data







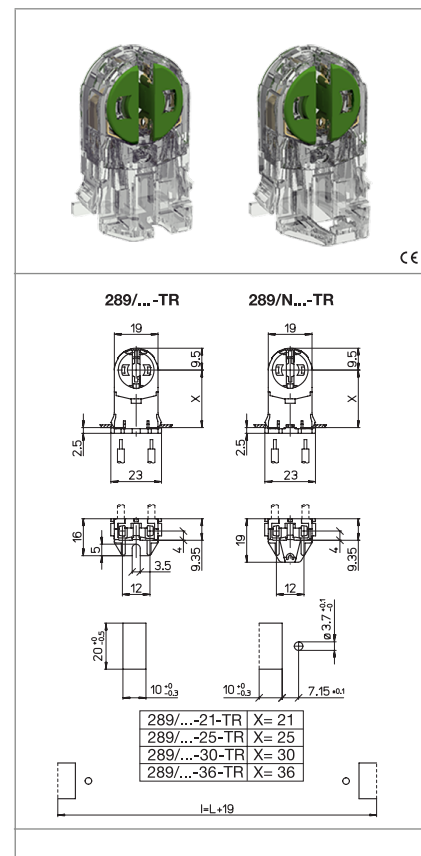

|   |               |
|---|---------------|
| - Attacco lampada<br>- Lamp Cap   | G5            |
| - Corrente e tensione nominale<br>- Rated current and voltage                         | 2A-500V       |
| - Temperatura massima di funzionamento (IEC)<br>- Maximum operating temperature (IEC) | T130<br>Tm110 |
| - Grado di protezione<br>- Protection index   | IP20          |
| - Categoria di sovratensione<br>- Impulse withstand category                          | III           |

**Caratteristiche**

Characteristics

- Corpo in policarbonato trasparente  
- Transparent polycarbonate body
- Contatti in lega di rame  
- Copper alloy contacts
- Con top test  
- With top test



|  |  |  |  |
|--|--|--|--|
|  fissaggio ad inserimento<br>push-through fixing                             |  spessore lamiera di fissaggio<br>fixing metal plate thickness<br>0,4-2 |  altezza centro lampada (da sotto la lamiera)<br>lamp centre height (from the bottom of the metal plate)<br>X |  versione con nasello<br>version with stop nib<br>N       |
|  rotore in PBT verde con scatti di...<br>PBT green rotor with position of... |  serrafilo automatico a 2 fori<br>push-wire terminals with 2 holes      |  sezione conduttori rigidi<br>rigid conductor section<br>mm <sup>2</sup><br>0,5-1                             |  spelatura cavetti rigidi<br>rigid wires stripping<br>8-9 |

**Marchi di qualità**

Quality marks

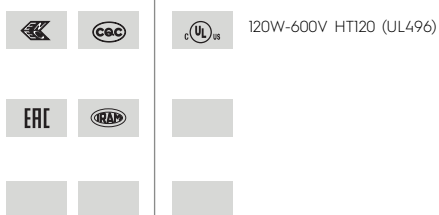

**Direttive Europee**

European directives

Conforme "RoHS"  
"RoHS" compliant  
Non soggetto alla "RAEE"  
Not subject to "WEEE"

**Pesi e confezioni**

Weights and packaging

| Art.<br>Codice prodotti<br>Product references | g<br>Peso netto<br>Net weight | n° pz<br>per sacco<br>per bag | n° pz<br>per scatola<br>per box | n° pz<br>per cartone<br>per carton |
|---|-------------------------------|-------------------------------|---------------------------------|------------------------------------|
| 289/21-TR                                     | 3,9                           | 1000                          |                                 |                                    |
| 289/25-TR                                     | 4                             | 1000                          |                                 |                                    |
| 289/30-TR                                     | 4,4                           | 1000                          |                                 |                                    |
| 289/36-TR                                     | 4,8                           | 1000                          |                                 |                                    |
| 289/N-21-TR                                   | 3,9                           | 1000                          |                                 |                                    |
| 289/N-25-TR                                   | 4                             | 1000                          |                                 |                                    |
| 289/N-30-TR                                   | 4,3                           | 1000                          |                                 |                                    |
| 289/N-36-TR                                   | 4,7                           | 1000                          |                                 |                                    |

**Note**

Notes