

480-1/5,8-CM

480-1/9,8-CM

PORTALAMPADE PER LAMPADE FLUORESCENTI COMPATTE
LAMPHOLDER FOR COMPACT FLUORESCENT LAMPS

Dati tecnici

Technical data

- Attacco lampada - Lamp Cap	GX53-1
- Corrente e tensione nominale - Rated current and voltage	2A-250V
- Temperatura massima di funzionamento (IEC) - Maximum operating temperature (IEC)	T110
- Grado di protezione - Protection index	IP20
- Categoria di sovratensione - Impulse withstand category	II









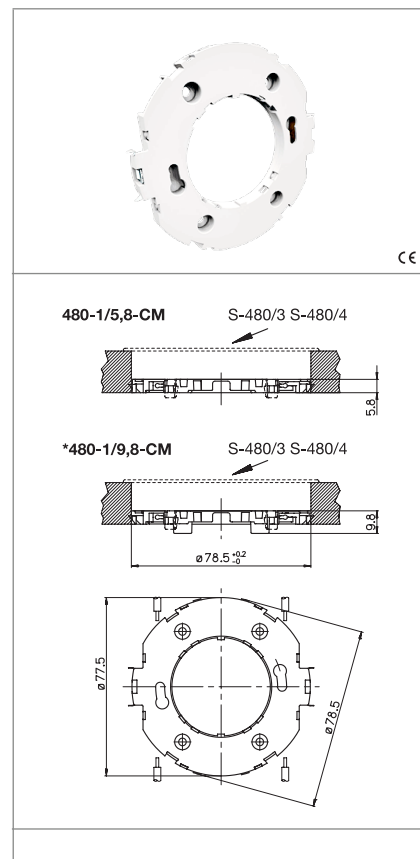

Caratteristiche

Characteristics

con molle laterali per fissaggio in pannelli
with side springs for fixing into panels

- Corpo in policarbonato bianco
- White polycarbonate body
- Contatti in lega di rame
- Copper alloy contacts



 fissaggio ad innesto snap-in fixing	 serrafilo automatico a 2 fori push-wire terminals with 2 holes	 sezione conduttori rigidi rigid conductor section	 diametro conduttore flessibile con fascetta diameter of the flexible conductor with ferrule
 spelatura cavetti rigidi e flessibili con fascetta rigid and flexible with ferrule wires stripping	 isolato in classe II class II insulated	 S-480/3	 S-480/4
 S-480-CB/2	 *S-480-CB		

Marchi di qualità

Quality marks

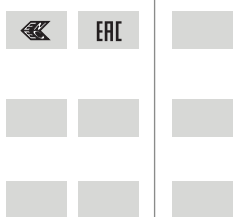

Direttive Europee

European directives

Conforme "RoHS"
"RoHS" compliant
Non soggetto alla "RAEE"
Not subject to "WEEE"

Pesi e confezioni

Weights and packaging

Art. Codice prodotti Product references	g Peso netto Net weight	n° pz per sacco per bag	n° pz per scatola per box	n° pz per cartone per carton
480-1/5,8-CM	11		200	
480-1/9,8-CM	11		200	

Note

Notes