

1902/T

1902/T-SN

PORTALAMPADE PROTETTI CON PORTASTARTER PER LAMPADE FLUORESCENTI T8, T8 + TUBO DI PROTEZIONE, T10, T12 PROTECTED LAMP HOLDERS WITH STARTERHOLDER FOR T8, T8 + COVER TUBE, T10, T12 FLUORESCENT LINEAR LAMPS

Dati tecnici

Technical data









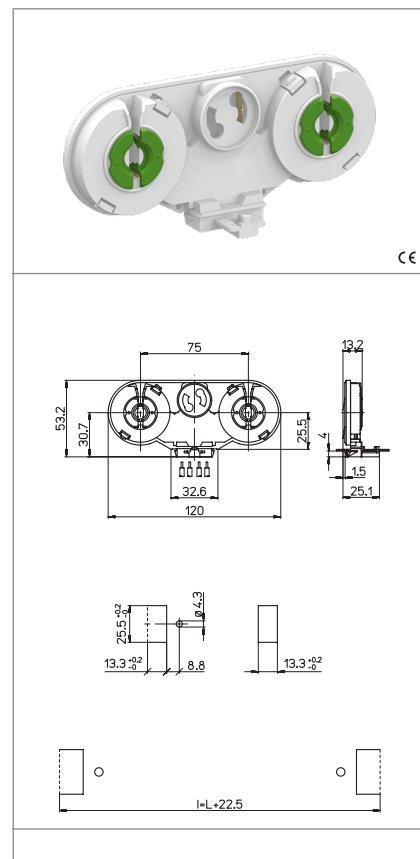

- Attacco lampada - Lamp Cap	G13
- Corrente e tensione nominale - Rated current and voltage	2A-250V
- Temperatura massima di funzionamento (IEC) - Maximum operating temperature (IEC)	T130 Tm110
- Grado di protezione - Protection index	IP40 con/with: S-1901/...
- Categoria di sovratensione - Impulse withstand category	II

Caratteristiche

Characteristics

- Corpo in policarbonato bianco
- White polycarbonate body
- Contatti in ottone
- Brass contacts



 fissaggio ad innesto snap-in fixing	 spessore lamiera di fissaggio fixing metal plate thickness 0,6-1,2	 altezza centro lampada (da sopra la lamiera) lamp centre height (from the top of the metal plate) 25,5	 adatto per fissaggio solo in cave da 13,3x25,5 mm suitable only for fixing into 13,3x25,5 mm holes
 versione senza nasello version without stop nib	 rotore in PBT verde con scatti di 45° PBT green rotor with position of... 45°	 serrafilo automatico ad 1 foro push-wire terminals with 1 hole	 sezione conduttori rigidi rigid conductor section mm ² 0,5-1
 spelatura cavetti rigidi rigid wires stripping 8-9	 IP40 con S-1901/... IP40 with S-1901/...		

Marchi di qualità

Quality marks

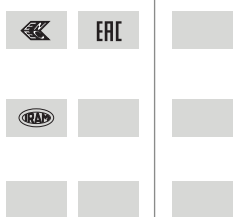

Direttive Europee

European directives

Conforme "RoHS"
"RoHS" compliant
Non soggetto alla "RAEE"
Not subject to "WEEE"

Pesi e confezioni

Weights and packaging

Art. Codice prodotti Product references	g Peso netto Net weight	n° pz per sacco per bag	n° pz per scatola per box	n° pz per cartone per carton
1902/T	30,3		100	
1902/T-SN	30,2		100	

Note

Notes