

422/V-q3-4-T

PORTALAMPADE MULTICHIAVE PER LAMPADE FLUORESCENTI COMPATTE (TC-DEL, TC-TEL) MULTI-KEYS LAMPHOLDERS FOR COMPACT FLUORESCENT LAMPS (TC-DEL, TC-TEL)

Dati tecnici

Technical data

- Attacco lampada - Lamp Cap	G24q-3 GX24q-3-4
- Corrente e tensione nominale - Rated current and voltage	2A-500V
- Temperatura massima di funzionamento (IEC) - Maximum operating temperature (IEC)	T140
- Grado di protezione - Protection index	IP20
- Categoria di sovratensione - Impulse withstand category	III









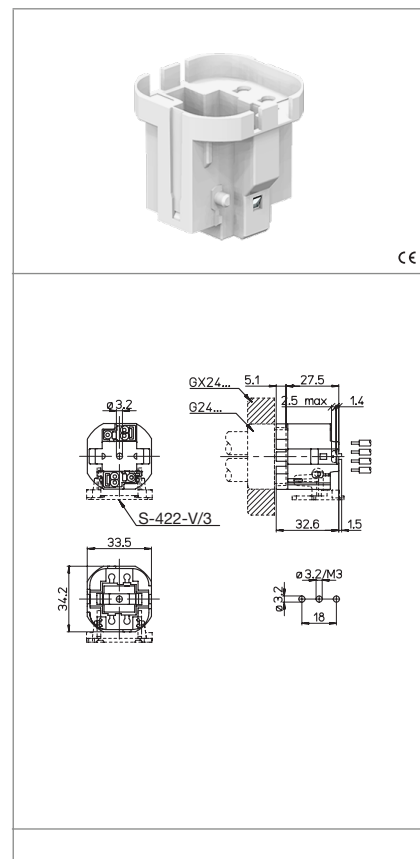



Caratteristiche

Characteristics

solo con reattori elettronici multipotenza
with multipower electronic ballasts only

- Corpo in PBT bianco
- White PBT body
- Contatti in lega di rame
- Copper alloy contacts



 fissaggio con vite screw fixing	 serrafilo automatico a 2 fori push-wire terminals with 2 holes	 sezione conduttori rigidi rigid conductor section	 spelatura cavetti rigidi rigid wires stripping
 con piolini antirotazione with anti-rotation pins	 con fori di guida per i cavetti with wires guidance holes	 isolato in classe II class II insulated	 S-422-V/3
			

Marchi di qualità

Quality marks

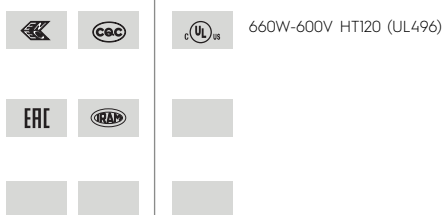

Direttive Europee

European directives

Conforme "RoHS"
"RoHS" compliant
Non soggetto alla "RAEE"
Not subject to "WEEE"

Pesi e confezioni

Weights and packaging

Art. Codice prodotti Product references	g Peso netto Net weight	n° pz per sacco per bag	n° pz per scatola per box	n° pz per cartone per carton
422/V-q3-4-T	12	500	200	

Note

Notes