

1423/L-d1-T

1423/L-d2-T

1423/L-d3-T

**PORTALAMPADE PER LAMPADIE FLUORESCENTI COMPATTE (TC-D)
LAMP HOLDERS FOR COMPACT FLUORESCENT LAMPS (TC-D)**

Dati tecnici

Technical data





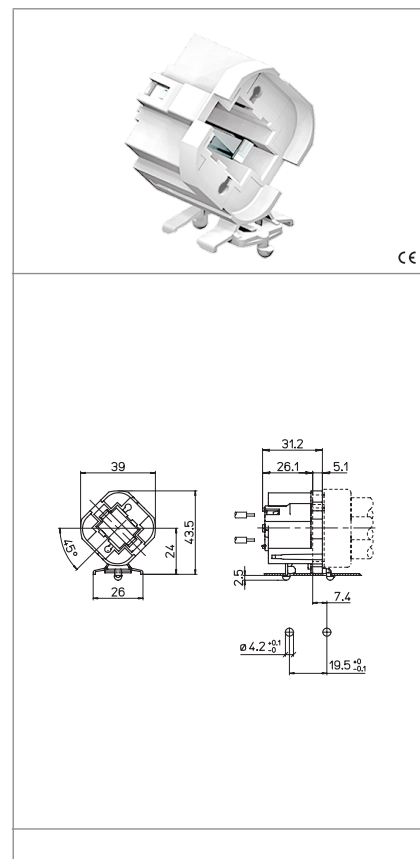

- Attacco lampada - Lamp Cap	G24d-1-2-3
- Corrente e tensione nominale - Rated current and voltage	2A-500V
- Temperatura massima di funzionamento (IEC) - Maximum operating temperature (IEC)	T140
- Grado di protezione - Protection index	IP20
- Categoria di sovratensione - Impulse withstand category	III

Caratteristiche

Characteristics

- Corpo in PBT bianco
- White PBT body
- Contatti in lega di rame
- Copper alloy contacts



 fissaggio ad innesto push-in fixing	 spessore lamiera di fissaggio fixing metal plate thickness 0,6-1,2	 altezza centro lampada (da sopra la lamiera) lamp centre height (from the top of the metal plate) 24	 serrafilo automatico a 2 fori push-wire terminals with 2 holes
 sezione conduttori rigidi rigid conductor section 0,5-1	 spelatura cavetti rigidi rigid wires stripping 10-11	 con fori di guida per i cavetti with wires guidance holes	 139

Marchi di qualità

Quality marks

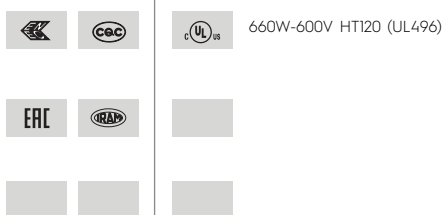

Direttive Europee

European directives

Conforme "RoHS"
"RoHS" compliant
Non soggetto alla "RAEE"
Not subject to "WEEE"

Pesi e confezioni

Weights and packaging

Art. Codice prodotti Product references	g Peso netto Net weight	n° pz per sacco per bag	n° pz per scatola per box	n° pz per cartone per carton
1423/L-d1-T				
1423/L-d2-T				
1423/L-d3-T	11,3	500		

Note

Notes